



# AIRWOLF FILTER, CORP

12801 Hwy 75 N

Okmulgee, Oklahoma 74447 U.S.A.

USA-1-(918) 561-8696 / (918) 561-8695 Fax

<http://www.airwolf.com> / Email: [support@airwolf.com](mailto:support@airwolf.com)



TO THE MECHANIC:

This P/N AFC-K007 remote mount oil filter kit incorporates our generic STC approved for all Lycoming powered aircraft up to 450 hp. The STC paperwork provided with this kit utilizes the new approved model list (AML) system recently instituted by the FAA. Although you may notice your particular aircraft is not specifically listed under this new classification, it is still approved.

Upon installing this filter kit, you will need to fill out and file a 337 form for this installation referencing the P/N AFC-K007 kit and the STC# SA00024NY. If your particular aircraft is not listed on the AML, you will also need a field approval by your local FSDO for this installation. This is necessary because the FAA only updates this list on a quarterly basis, and until your aircraft is listed, a field approval is required. If you are unsure whether or not you need a field approval, please call us directly.

With this paperwork, your local FSDO inspector has all the approved engineering data necessary to issue a field approval. This inspector is not an engineer and typically all he is doing is seeing if you installed it I/A/W the installation instructions and usually to make sure it doesn't leak. That's it.

If your local FSDO inspector has any questions or concerns on this STC, he is to call the Aircraft Certification Office which will clarify the details. They are very familiar with our filter kits and can address any concerns your FSDO inspector may have on your particular installation.

FAA - Chicago Aircraft Certification Office (CHI-ACO)  
Engine and Propeller Division  
2300 East Devon Avenue  
Room 107  
Des Plaines, IL 60018  
(847) 294-7358 / (817) 294-7834 Fax

**FAA APPROVED**

*Cy*  
OCT 03 2012

CHICAGO AIRCRAFT  
CERTIFICATION OFFICE  
CENTRAL REGION

If your aircraft required a field approval, we must have a copy in order to update the (AML) list on our STC. Please send us a copy in addition to the one you will file with your local FSDO. We will then forward our copy to the Aircraft Certification Office for them to update the (AML) list on our STC.

## **DATA PERTINENT TO ALL INSTALLATIONS**

**Prior to installing the filter kit on the aircraft, weigh the filter kit, add the weight of the hoses, and subtract the oil screen or oil filter adapter removed from the engine, and determine the net weight being added to the aircraft for determining the weight and balance of the aircraft later. Once the filter kit is installed on the aircraft, if you choose to purchase the hoses from Airwolf, we will supply you with the Teflon Hoses specified in this STC. At the time of the order we will need the flare to flare length of the hoses, and hose ends needed on each hose ie: Straight to Straight, Straight to 90°, Straight to 45°, etc. allowing for engine torque and vibration per AC43.13.**

**If our instructions do not specifically say your allowed to do something, assume that means you are not allowed to do it without our written approval**

Thank you for your help.

***Airwolf Filter Corp.***

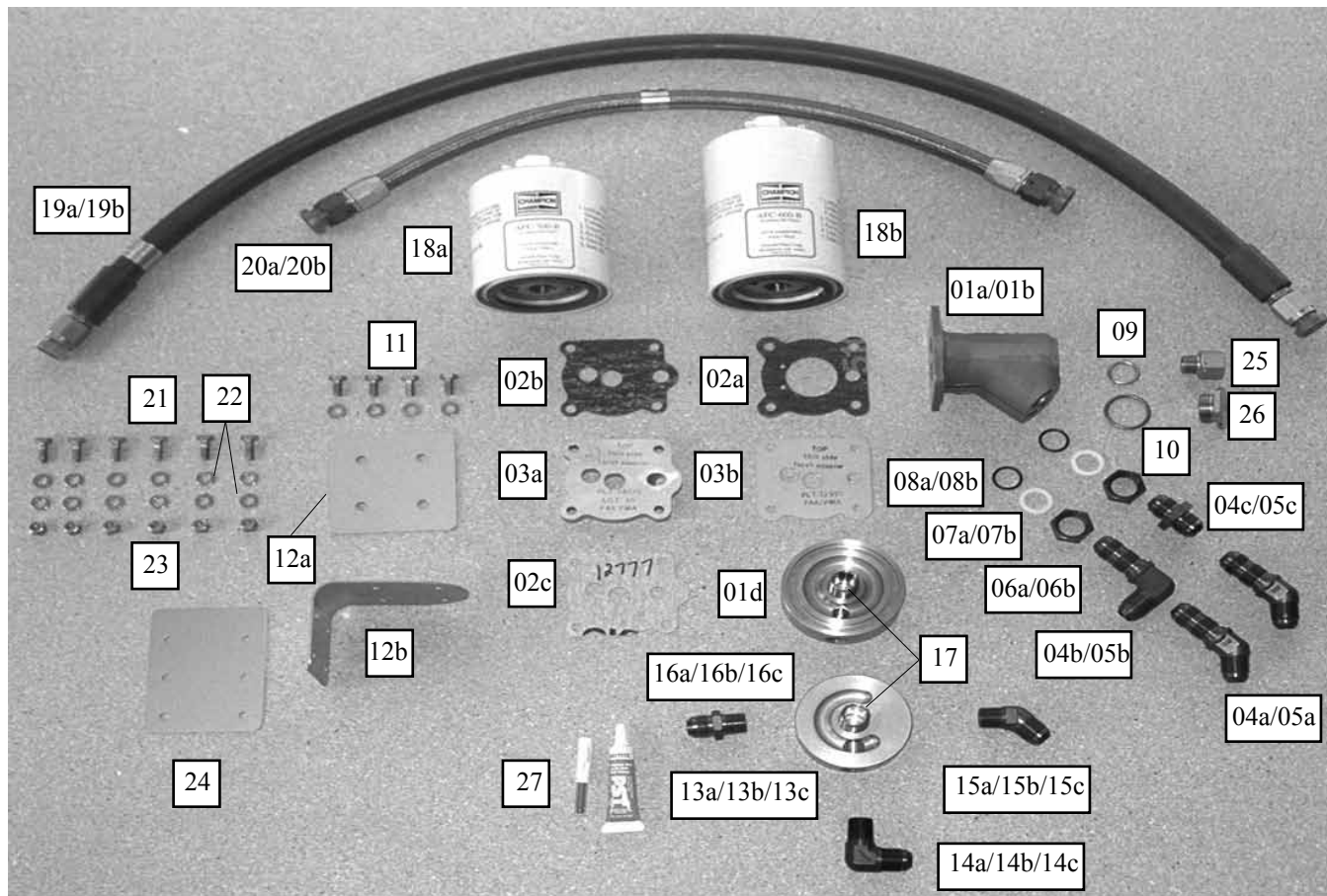

### Oil Filter Kit AFC-K007

**Applicability:**

Lycoming powered Single and Multi Engine  
Fixed Wing Aircraft less than 450hp.  
having firewalls of .021 ASTM A527 galvanized steel or equivalent.

**Drawing:** AFC-K007  
**Revision:** C  
**Date:** 11/11/10

Parts List No. AFC-K007-PL

<u>Index</u>	<u>Part Number</u>	<u>Description</u>	<u>Quantity</u>
01a.	LYC-10	Full Flow Engine Adapter, All O235-540 except below	(1)
01b.	LYC-11	Full Flow Engine Adapter, IO720	(1)
01c.	OFB-12	Full Flow Engine Adapter, Single Drive Dual Mags [Old Style]	(1)
01d.	OFB-17	Full Flow Engine Adapter, Single Drive Dual Mags [New Style]	(1)
01e.	M83248/1-230	"O" Ring, Viton, Single Drive Dual Mags [New Style]	(1)
01f.	AN919-15D-SP	Fitting, Reducer, -10 -> -8 Single Drive Dual Mags [New Style]	(2)
02a.	61173	Adapter Base Gasket, O235-540	(1)
02b.	12777	Adapter Base Gasket, IO720	(1)
02c.	12776	Adapter Base Gasket, IO720	(1)
03a.	PLT-28775	Adapter Plate, IO720	(1)
03b.	PLT-12999	Restrictor Plate, O235	(1)
04a.	AN837-8D	Bulkhead Fitting-45°, O235-540	(2)
04b.	AN833-8D	Bulkhead Fitting-90°, O235-540	(Opt)
04c.	AN815-8D	Union, O235-540	(Opt)
05a.	AN837-10D	Bulkhead Fitting-45°, IO720	(2)
05b.	AN833-10D	Bulkhead Fitting-90°, IO720	(Opt)
05c.	AN815-10D	Union, IO720	(Opt)
06a.	AN6289-8D	Bulkhead Nut, O235-540	(2)
06b.	AN6289-10D	Bulkhead Nut, IO720	(2)
07a.	MS28773-08	Boss Gasket, Teflon, O235-540	(2)
07b.	MS28773-10	Boss Gasket, Teflon, IO720	(2)
08a.	MS9387-08	"O" Rings, Viton, O235-540	(2)
08b.	MS9387-10	"O" Rings, Viton, IO720	(2)
09.	MS35769-11	Gasket, Oil Temperature Sensor	(1)
10.	MS35769-21	Gasket, Thermostatic Valve	(1)

**Applicability:** Lycoming powered Single and Multi Engine  
Fixed Wing Aircraft less than 450hp.  
having firewalls of .021 ASTM A527 galvanized steel or equivalent.

**Drawing:** AFC-K007  
**Revision:** C  
**Date:** 11/11/10

**Parts List No. AFC-K007-PL (continued)**

<b>Index</b>	<b>Part Number</b>	<b>Description</b>	<b>Quantity</b>
11.	AN4H-4A	Bolts, Drilled Head	(4)
12a.	OFM-10	Horizontal Oil Filter Mount Plate	(1)
12b.	OFM-11	Vertical Oil Filter Mount Plate	(1)
13a.	OFB-10	Oil Filter Base, -8 Ports, O235-540	(1)
13b.	OFB-11	Oil Filter Base, -10 Ports, IO720	(1)
13c.	OFB-15	Oil Filter Base, -12 Ports, GO/GSO/IGSO 435/480/540	(1)
14a.	MS20822-8D	90° Fitting, O235-540	(1)
14b.	MS20822-10D	90° Fitting, IO720	(1)
14c.	MS20822-12D	90° Fitting, GO/GSO/IGSO 435/480/540	(1)
14d.	AN842-16D	90° Fitting, W670	(1)
15a.	MS20823-8D	45° Fitting, O235-540	(1)
15b.	MS20823-10D	45° Fitting, IO720	(1)
15c.	MS20823-12D	45° Fitting, GO/GSO/IGSO 435/480/540	(1)
15d.	AN844-16D	45° Fitting, W670	(1)
16a.	AN816-8D	Nipple, Flared Tube, O235-540	(Opt)
16b.	AN816-10D	Nipple, Flared Tube, IO720	(Opt)
16c.	AN816-12D	Nipple, Flared Tube, GO/GSO/IGSO 435/480/540	(Opt)
16d.	AN840-16D	Nipple, W670	(Opt)
17.	OFS-10	Oil Filter Stud	(1)
18a.	AFC-500	Oil Filter, Std. or Equivalent [Champion CH48108]	(1)
18b.	AFC-600	Oil Filter, Long or Equivalent [Champion CH48109]	(1)
19a.	F13000008-0xxx	Titeflex® Firesleeved Teflon Hose, [-8], O235-540	(Opt)
19b.	F13000010-0xxx	Titeflex® Firesleeved Teflon Hose, [-10], IO720	(Opt)
19c.	F13000012-0xxx	Titeflex® Firesleeved Teflon Hose, [-12], GO/GSO/IGSO 435/480/540	(Opt)
20a.	AE7010000H0xxz	Aeroquip® Hose Assy, [-8], O235-540	(Opt)
20b.	AE7010000J0xxz	Aeroquip® Hose Assy, [-10], IO720	(Opt)
20c.	AE7010000K0xxz	Aeroquip® Hose Assy, [-12], IGO/GSO/IGSO 435/480/540	(Opt)
20d.	MIL6000-1-25	MIL 6000 Hose, 25" Long, [Stearman]	(2)
20e.	MIL6000-3/4-25	MIL 6000 Hose, 25" Long, [Waco]	(2)
21.	AN4-5A	Bolts	(6)
22.	AN960-416	Flat Washers	(16)
23.	MS20365-428A	Locknuts	(6)
24.	DBL-10	Doubler Plate	(1)
25.	OTA-527	Oil Temp Adapter	(Opt)
26.	CAP-1350	Bypass Valve Cap	(Opt)
27.	LYC-12	Full Flow Engine Adapter-Engine Mounted	(1)
28.	PLT-200	2" Adapter Plate	(1)
29.	AN74A-6	Drilled Head Bolts	(4)
30.	MS35333-40	1/4" Star Washer	(8)
31.	56707	Loctite® 567 PST Teflon Thread Sealant	(1)
32.	AFC-K007-II	Installation Instructions, Generic	(1)
33.	AFC-K007-MI	Instructions for Continued Airworthiness	(1)
34.	AFC-K007-PL	Parts List	(1)

**\*\*\*\*\* WARNING (A) \*\*\*\*\***

**USE LOCTITE® 567 PST TEFLON THREAD SEALANT BEFORE INSTALLATION OF FITTINGS. DO NOT ASSEMBLE FITTINGS INTO OIL FILTER BASE WITHOUT SEALANT OTHERWISE GALLING OF MATERIAL WILL RESULT.**

**\*\*\*\*\* WARNING (B) \*\*\*\*\***

**LOCAL STIFFENING OF THE FIREWALL MAY BE NECESSARY TO SUPPORT WEIGHT OF OIL FILTER AND PREVENT FIREWALL CRACKING.**

**\*\*\*\*\* WARNING (C) \*\*\*\*\***

**NO ROUTING OF FLAMMABLE FLUID LINES ABOVE EXHAUST SYSTEM, UNLESS FIRESLEEVED. INSTALLER IS RESPONSIBLE FOR INTER-RELATIONSHIP BETWEEN THIS AND OTHER ENGINE CHANGES (INCLUDING ACCESSORIES)**

**Installation Instructions No. AFC-K007-A-II**

**Applicability:**

Lycoming powered Single and Multi Engine  
Fixed Wing Aircraft with O235-O540 engines  
having firewalls of .021 ASTM A527 galvanized steel or equivalent.

**Drawing:** AFC-K007  
**Revision:** C  
**Date:** 11/11/10

**Note A:** Some hoses or wires may have to be rerouted so the oil filter assembly will fit into position.  
Reference and material per AC 43.13-1B & 2A.

01. Remove the Lycoming P/N 69510, 68974 or 62815 engine oil screen housing from the accessory case.  
**\*\* WARNING - DO NOT REUSE OIL SCREEN IN LYC-10 ADAPTER \*\***
02. Remove oil temperature sensor and thermostatic valve from old oil screen housing.
03. Install a new gasket (09) under the head of the oil temperature sensor, reinstall in the adapter-engine (01a). Turn the oil temp sensor until the sealing surfaces are in contact and then tighten an additional 135 degrees. Install a new gasket (10) under the head of the Lycoming P/N 75944 thermostatic valve, reinstall in the adapter-engine (01a), torque to 300 in/lbs and secure.

**Note B:** You must use the Bypass Valve Cap (26) if your aircraft uses an older Lycoming engine which does not utilize the newer type Lycoming P/N 53E22144 thermostatic bypass valve (Vernatherm) as your accessory case may not have been drilled by the Lycoming factory to utilize the Vernatherm.

**Note C:** If removing the 68974 or 62815 oil screen housing from your engine which uses the older type capillary tube oil temperature probe and you intend to reuse this probe in our LYC-10 Adapter, it may be necessary to use our Oil Temp Adapter (25).

04. Onto each bulkhead fitting (04a) or (04b), install in order 1 ea. bulkhead nut (06a), boss gasket (07a), and "O" Ring (08a). If using union (04c), use only "O" Ring (08a). Install each completed assembly into the adapter-engine (01a).  
**BE CAREFUL:** O-ring and boss gasket must seal in the smooth area between the threaded areas of the bulkhead fitting.

**Note D:** Any combination of fittings (04a), (04b), or (04c) is acceptable.

05. Install a new gasket (02a) on base of adapter-engine (01a) and reinstall onto the engine accessory case. Torque to specifications 96 in/lbs. On O235 Series engines, a restrictor plate (03b) must be used to keep the engine oil pressure from following the throttle. Install as pictured using 1 ea. adapter base gasket (02a) on each side of the restrictor plate.
06. Using the horizontal oil filter mount (12a.) or vertical oil filter mount (12b.) as a drilling template, locate and drill mounting holes using a letter "F" drill.  

**\*\*\*\*\* SEE WARNING (A) ABOVE \*\*\*\*\***
- 07a. Secure oil filter mount plate - vertical (12b) to Fwd side of firewall and doubler plate (24) to Aft side of firewall using bolts (21), washers (22), and nuts (23).  

OR
- 07b. Secure oil filter base (13a) to Fwd side of firewall and horizontal oil filter mount plate (12a) to rear side using bolts (11) and washers (22) and secure with .032 MS20995-C safety wire.  

**\*\*\*\*\* SEE WARNING (B) ABOVE \*\*\*\*\***
08. Install any combination of fitting (14a), (15b), or (16a) into oil filter base (13a). Mount to oil filter mount plate (12a.) or (12b.) using bolts (11), washers (22), and secure with .032 MS20995-C safety wire.  

**\*\*\*\*\* SEE WARNING (C) ABOVE \*\*\*\*\***
09. Determine hose lengths and order appropriate length hoses (19a) or (20a). Last 2 xx's in part number is the length of the hose in inches and the z is the length in eighths of an inch. Ex. P/N for a firesleeved hose 24 7/8" long is F13000008-0247.
10. Install assembled hose assy's (19a) or (20a) connecting the "A" port on the Adapter- Engine to the "A" port on the filter base and the "B" port on the Adapter- Engine to the "B" port on the filter base and torque to 270-350 in/ lbs.
11. Install oil filter (18a) or (18b) torque per instructions on oil filter, and secure with MS20995-C safety wire.
12. Run engine and check for leaks.
13. Determine weight and balance, initiate a 337 form, and update the equipment list.

**Installation Instructions No. AFC-K007-B-II**

**Applicability:**

Lycoming powered Single and Multi Engine  
Fixed Wing Aircraft less than 450hp, using Single Drive Dual Mags  
having firewalls of .021 ASTM A527 galvanized steel or equivalent.

**Drawing:** AFC-K007  
**Revision:** C  
**Date:** 11/11/10

**Note A:** Some hoses or wires may have to be rerouted so the oil filter assembly will fit into position.  
Reference and material per AC 43.13-1B & 2A.

01. Remove existing spin on oil filter from rear of accessory case.
02. Remove Champion P/N CH48212 Converter Stud from rear of accessory case.   
**DO NOT remove the Champion P/N CH48210 converter plate and gasket.**
03. For old style OFB-14 (01c) oil filter adapter:  
Remove square cut O-Ring from base of old Champion oil filter being removed from accessory case.  
Reinstall square cut O-Ring previously removed from oil filter into base of oil filter adapter (01c). Apply liberal amount of Dow Corning DC-4 silicon grease to O-Ring and place in machined groove in oil filter adapter (01c) and install onto the accessory case. O-Ring should extend approximately .040 above the surface of the oil filter adapter(01c)  

**\*\*\*\*\* SEE WARNING (A) ABOVE \*\*\*\*\***
04. Install any combination of fitting (14a), (15a), or (16a) into oil filter adapter (01c).
05. For new style OFB-17 (01d) oil filter adapter :  
Apply liberal amount of Dow Corning DC-4 silicon grease to O-Ring (01e.) Install O-ring (01e.) into machined groove in oil filter adapter (01d) and install onto the accessory case.
06. Place O-rings (08b) onto fillings (01f) and install into oil filter adapter (01d).
07. Install assembled oil filter adapter (01c) or (01d) onto rear of accessory case. Torque to specifications 16-18 ft./lbs. and secure with .032 MS20995-C safety wire.
08. Using the horizontal oil filter mount (12a.) or vertical oil filter mount (12b.) as a drilling template, locate and drill mounting holes using a letter "F" drill.  

**\*\*\*\*\* SEE WARNING (B) ABOVE \*\*\*\*\***
- 09a. Secure oil filter vertical mount plate (12b) to Fwd side of firewall and doubler plate (24) to Aft side of firewall using bolts (21), washers (22), and nuts (23).  

OR
- 09b. Secure oil filter base (13a) to Fwd side of firewall and oil filter mount plate - horizontal (12a) to rear side using bolts (11) and washers (22) and secure with .032 MS20995-C safety wire.  

**\*\*\*\*\* SEE WARNING (A) ABOVE \*\*\*\*\***
10. Install any combination of fitting (14a), (15a), or (16a) into oil filter base (13a). Mount to oil filter mount plate (12a.) or (12b.) using bolts (09), washers (17), and secure with .032 MS20995-C safety wire.  

**\*\*\*\*\* SEE WARNING (C) ABOVE \*\*\*\*\***
11. Determine hose lengths and order appropriate length hoses (19a) or (20a). Last 2 xx' s in part number is the length of the hose in inches and the z is the length in eighths of an inch. Ex. P/N for a firesleeved hose 24 7/8" long is F1300008-0247.
12. Install assembled hose assy's (19a) or (20a) connecting the "A" port on the oil filter adapter to the "A" port on the oil filter base and the "B" port on the oil filter adapter to the "B" port on the oil filter base and torque to 270-350 in/ lbs.
13. Install oil filter (18a) or (18b), torque per instructions on oil filter, and secure with MS20995-C safety wire.
14. Run engine and check for leaks.
15. Determine weight and balance, initiate a 337 form, and update the equipment list.

**Installation Instructions No. AFC-K007-C-II**

<b>Applicability:</b>	<b>Lycoming powered Single and Multi Engine Fixed Wing Aircraft with IO-720 engines having firewalls of .021 ASTM A527 galvanized steel or equivalent.</b>	<b>Drawing:</b>	<b>AFC-K007</b>
		<b>Revision:</b>	<b>C</b>
		<b>Date:</b>	<b>11/11/10</b>

**Note A:** Some hoses or wires may have to be rerouted so the oil filter assembly will fit into position.  
Reference and material per AC 43.13-1B & 2A.

01. Remove the Lycoming P/N 73300 engine oil screen housing or P/N 77852 oil filter base assy. from the accessory case.  
**\*\* WARNING - DO NOT REUSE OIL SCREEN IN LYC-II ADAPTER \*\***
02. Remove oil temperature sensor and thermostatic valve from old oil screen housing.
03. Install a new gasket (09) under the head of the oil temperature sensor and install into adapter-engine (01b). Turn the oil temp sensor until the sealing surfaces are in contact and then tighten an additional 135 degrees. Install a new gasket (10) under the head of the Lycoming P/N 75944 thermostatic valve, reinstall in the adapter-engine (01b), torque to 300 in/lbs and secure.
04. Onto each bulkhead fitting (05a) or (05b), install in order 1 ea. bulkhead nut (06b), boss gasket (07b), and "O" Ring (08b). If using union (05c), use only "O" Ring (08b). Install each completed assembly into the adapter-engine (01b).  
**BE CAREFUL:** O-ring and boss gasket must seal in the smooth area between the threaded areas of the bulkhead fitting.

**Note B:** Any combination of fittings (05a), (05b), or (05c) is acceptable.

**\*\*\*\*\* SEE WARNING (A) ABOVE \*\*\*\*\***

05. Onto accessory case, install in order 1 ea. gasket, oil filter adapter (02c), adapter plate IO720 (03), adapter base gasket (02b). Trim gaskets as necessary to assure oil flow returning to the engine (far RH hole) is not restricted and that there is a smooth flow from the gasket (02c), adapter (03) and gasket.(02b). Install assembled adapter-engine (01b) onto the engine accessory case and torque to specifications 96 in/lbs.

**\*\*\*\*\* SEE WARNING (B) ABOVE \*\*\*\*\***

06. Using the oil filter horizontal mount (12a.) or vertical oil filter mount (12b.) as a drilling template, locate and drill mounting holes using a letter "F" drill.
- 07a. Secure vertical oil filter mount plate (12b) to Fwd side of firewall and doubler plate (24) to Aft side of firewall using bolts (21), washers (22), and nuts (23).
- OR
- 07b. Secure oil filter base (13b) to Fwd side of firewall and horizontal oil filter mount plate (12a) to rear side using bolts (11) and washers (22) and secure with .032 MS20995-C safety wire.

**\*\*\*\*\* SEE WARNING (C) ABOVE \*\*\*\*\***

08. Install any combination of fitting (14b), (15b), or (16b) into oil filter base (13b). Mount to oil filter mount plate (12a.) or (12b.) using bolts (11), washers (22), and secure with .032 MS20995-C safety wire.

**\*\*\*\*\* SEE WARNING (D) ABOVE \*\*\*\*\***

09. Determine hose lengths and order appropriate length hoses (19b) or (20b). Last 2 xx' s in part number is the length of the hose in inches and the z is the length in eighths of an inch. Ex. P/N for a firesleeved hose 24 7/8" long is F13000010-0247.
10. Install assembled hose assy's (19b) or (20b) connecting the "A" port on the Adapter- Engine to the "A" port on the filter base and the "B" port on the Adapter- Engine to the "B" port on the filter base and torque to 270-350 in/ lbs.
11. Install oil filter (18b), torque per instructions on oil filter, and secure with MS20995-C safety wire.
12. Run engine and check for leaks.
13. Determine weight and balance, initiate a 337 form, and update the equipment list.

**Installation Instructions No. AFC-K007-D-II**

**Applicability:**

Lycoming powered Single and Multi Engine  
Fixed Wing Aircraft with G0/GSO/IGSO 435/480/540 engines  
having firewalls of .021 ASTM A527 galvanized steel or equivalent.

**Drawing:** AFC-K007  
**Revision:** C  
**Date:** 11/11/10

**Note A:** Some hoses or wires may have to be rerouted so the oil filter assembly will fit into position.  
Reference and material per AC 43.13-1B & 2A.

01. Gain access to the engine compartment.
02. Locate the scavenge oil hose connecting the scavenge oil pump to the oil cooler.
03. Locate and determine proposed oil filter location on firewall.
04. Using the vertical oil filter mount (12b.) as a drilling template, locate and drill mounting holes using a letter "F" drill.  

**\*\*\*\*\* SEE WARNING (A) ABOVE \*\*\*\*\***
05. Secure the vertical oil filter mount (12b.) to Fwd side of firewall and doubler plate (24) to Aft side of firewall using bolts (21), washers (22), and nuts (23).  

**\*\*\*\*\* SEE WARNING (B) ABOVE \*\*\*\*\***
06. Install any combination of fitting (14c), (15c), or (16c) into oil filter base (13a). Mount to oil filter mount plate (12a.) or (12b.) using bolts (11), washers (22), and secure with .032 MS20995-C safety wire.  

**\*\*\*\*\* SEE WARNING (C) ABOVE \*\*\*\*\***
07. Determine hose lengths and order appropriate length hoses (19a) or (20a). Last 2 xx' s in part number is the length of the hose in inches and the z is the length in eighths of an inch. Ex. P/N for a firesleeved hose 24 7/8" long is F13000012-0247.
08. Install assembled hose assy's (19c) or (20c) connecting the outlet port on the scavenge oil pump to the "B" port on the oil filter base (13c). Connect the outlet ["A" port] of the oil filter base (13c) to the inlet of the oil cooler. Torque hoses to 270-350 in/ lbs.
09. Install oil filter (18b) torque per instructions on oil filter, and secure with MS20995-C safety wire.
10. Run engine and check for leaks.
11. Determine weight and balance, initiate a 337 form, and update the equipment list.



**Installation Instructions No. AFC-K007-F-II**

<b>Applicability:</b>	<b>Lycoming powered Single and Multi Engine Fixed Wing Aircraft less than 450hp. having firewalls of .021 ASTM A527 galvanized steel or equivalent.</b>	<b>Drawing:</b>	<b>AFC-K007</b>
		<b>Revision:</b>	<b>C</b>
		<b>Date:</b>	<b>11/11/10</b>

**Note A: Some hoses or wires may have to be rerouted so the oil filter assembly will fit into position. Reference and material per AC 43.13-1B & 2A.**

01. Remove existing spin-on oil filter from Lycoming P/N 77852 Oil Filter Adapter.
02. Screw OFB-17 oil filter adapter completely into existing Lycoming P/N 77852 and see if both parts make contact. If any gap exists, measure the gap, add .187 to this dimension and trim the OFS-10 oil filter stud to this length. When trimmed to the correct length the OFB-17 will make contact with the 77852 adapter without the o-ring installed in our OFB-17 adapter.

**Note B: Lycoming has recently changed the amount of threads inside their P/N 77852 adapter which can cause our OFS-10 stud to bottom out before the actual OFB-17 makes contact with the adapter, requiring the trimming of our OFS-10 stud.**

03. Apply liberal amount of Dow Corning DC-4 silicon grease to the M83248/1-230 O-Ring. Install the O-ring into machined groove in OFB-17 oil filter adapter and install onto Lycoming P/N 77852 Oil Filter Adapter. Do not tighten completely at this time.
04. Place MS9387-10 o-rings onto AN919-15D-SP fittings and install into OFB-17 oil filter adapter.
05. Using the OFM-10 horizontal oil filter mount or OFM-11 vertical oil filter mount as a drilling template, locate and drill mounting holes using a letter "F" drill.

**\*\*\*\*\* SEE WARNING (B) ABOVE \*\*\*\*\***

- 06a. Secure OFM-11 vertical oil filter mount plate to Fwd side of firewall and DBL-10 doubler plate to Aft side of firewall using AN4-5A bolts, AN960-416 washers and MS20365-428A nuts supplied.  
OR
- 06b. Secure OFB-10 oil filter base to Fwd side of firewall and OFM-10 horizontal oil filter mount plate to rear side using AN4H-4A bolts and AN960-416 washers supplied and secure with .032 MS20995-C safety wire.

**\*\*\*\*\* SEE WARNING (A) ABOVE \*\*\*\*\***

07. Install any combination of fitting (14a), (15a), or (16a) into OFB-10 oil filter base. Mount to OFM-10 or OFM-11 oil filter mount plate using AN4H-4A bolts and AN960-416 washers, and secure with .032 MS20995-C safety wire.

**\*\*\*\*\* SEE WARNING (C) ABOVE \*\*\*\*\***

08. Determine hose lengths and order appropriate length hoses (19a) or (20a). Last 2 xx' s in part number is the length of the hose in inches and the z is the length in eighths of an inch. Ex. P/N for a firesleeved hose 24 7/8" long is F1300008-0247.
09. Install assembled hose assy's (19a) or (20a) connecting the "A" port on the oil filter adapter to the "A" port on the oil filter base and the "B" port on the oil filter adapter to the "B" port on the oil filter base and torque to 270-350 in/ lbs.
10. Install AFC-500 or AFC-600 oil filter and torque per instructions on oil filter, and secure with MS20995-C safety wire.
11. Torque tOFB-17 adapter at this time to specifications 16-18 ft./lbs. and secure with .032 MS20995-C safety wire.
12. Run engine and check for leaks.
13. Determine weight and balance, initiate a 337 form, and update the equipment list.



**Installation of the remote oil filter kit on Boeing Model 75 series aircraft with Lycoming R-680 radial engines.**

**Drawing: AFC-K007  
Revision: C  
Date: 11/11/10**

**Note A: Some hoses or wires may have to be rerouted so the oil filter assembly will fit into position. Reference and material per AC 43.13-1B & 2A.**

01. Remove left engine cowl (top and door) and bottom engine cowl.
  02. Drain oil (optional).
  03. Remove engine oil return line P/N A75N1-3004 (note this may be a length of 1" Mil 6000 hose). This line runs from the engine to the oil tank.
  04. Turn the AN842-16D on top of the oil tank to where it points to the engine primer mounted in the step.
  05. Remove the screw that goes through the end of the firewall stiffener P/N 75-2912. This is located on the left side of the firewall on the aft side. Loosen the screw that goes through the firewall stiffener and the tab welded on the fuselage. This screw is 4-5/16" inboard of the removed screw. (see attached drawing). Drill the hole of the removed screw to 1/4" (.250).
  06. Measure 3-9/16" out from a vertical line drawn from the C/L of the left engine mount studs. Using reinforcing plate P/N DBL-10 as a template drill the other 5 holes 1/4" (.250). The previously drilled hole is the middle outboard hole.
  07. Slip reinforcement plate (DBL-10) between the firewall and stiffeners. The long side goes up.
  08. Bolt oil filter base support angle P/N OFM-11 to firewall and reinforcement plate using(6ea) provided AN 4-5A bolts.
- \*\*\*\*\* SEE WARNING (B) ABOVE \*\*\*\*\***
09. Install provided AN842-816D fittings in the oil filter base. The fitting in B hole points horizontal with the filter base. The other points over the first fitting.
  10. Bolt oil filter base (OFB-15) to oil Vertical Filter Mount Plate (12b) using provided AN4H-4A bolts. Oil inlet hole "B" on the oil filter base is positioned to the front of the aircraft. Secure bolts with safety wire.
  11. Install one 25" piece of 1" Mil 6000H hose using provided QS100M16H hose clamps. The "B" hole on the oil filter base is the oil inlet and comes from the outlet of the scavenge oil pump. The "A" port is the outlet of the oil filter base is the return line to the top of the oil tank. Tighten clamps.
  12. Install oil filter as per manufacturers specifications and safety wire.
  13. Using the 2" piece of 3/4" Mil 6000 hose provided, secure to bottom of oil filter with (1) QS100M52W 3-3/4" clamp obtained locally, and locate between bottom of oil filter and existing firewall. This will strengthen the oil filter mount and dampen the vibrations of the engine.
  14. Safety wire drain and refill oil tank with 4.4 gals. oil. (If step #2 is omitted this step is not necessary).
  15. Run engine and check for leaks.
  16. Determine weight and balance, initiate 337 form, and update the equipment list.

**\*\*\*\*\* WARNING (C) \*\*\*\*\***

**NEVER, EVER INSTALL AN OIL FILTER ON THE ENGINE OIL PUMP INLET.  
THE OIL LINES CAN COLLAPSE, THEREBY STARVING THE ENGINE OF OIL.**

**THE OIL ROUTING AND OIL FLOW IS ALWAYS;**

**ENGINE SCAVENGE PUMP OUTLET ---> AIRWOLF OIL FILTER ---> OIL COOLER [if applicable] ---> OIL TANK.**

**Installation Instructions No. AFC-K007-H-II**

<b>Applicability:</b>	<b>Lycoming powered Single and Multi Engine</b>	<b>Drawing:</b>	<b>AFC-K007</b>
	<b>Fixed Wing Aircraft less than 450hp.</b>	<b>Revision:</b>	<b>C</b>
	<b>having firewalls of .021 ASTM A527 galvanized steel or equivalent.</b>	<b>Date:</b>	<b>11/11/10</b>

**Note A:** Some hoses or wires may have to be rerouted so the oil filter assembly will fit into position. Reference and material per AC 43.13-1B & 2A.

01. Remove existing oil temperature probe and Vernatherm® [oil cooler bypass valve] from existing Lycoming P/N 77852 Spin-On Oil Filter Adapter or P/N P/N 69510, 68974 or 62815 oil screen housing.
02. Remove existing spin on oil filter from Lycoming P/N 77852 Spin-On Oil Filter Adapter or P/N P/N 69510, 68974 or 62815 oil screen housing from rear accessory case.
03. Using Adapter Base Gasket (02a) provided, install 2" Adapter Plate (28) on rear onto accessory case using original nuts, washers, and lockwashers, and torque to 96 in/lbs.

**Note B:** This Adapter Plate can only be positioned one way. Make sure holes in adapter match up with oil holes in accessory case.

04. Using Adapter Base Gasket (02a) provided, install Full Flow Engine Adapter (27) onto newly installed 2" adapter plate using drilled head bolts (29) and flat washers (22) provided, torque to 96 in/lbs, and secure with .032 MS20995-C safety wire.
05. Install a new gasket (09) under the head of the oil temperature sensor and install in the engine adapter (27). If your temperature sensor is located in a different area on the accy case, use Lycoming P/N 62417 cap to plug off this hole. Turn the oil temp sensor until the sealing surfaces are in contact and then tighten an additional 135 degrees.

**Note C:** If removing the 68974 or 62815 oil screen housing from your engine which uses the older type capillary tube oil temperature probe and you intend to reuse this probe in our LYC-12 Adapter, it may be necessary to use our Oil Temp Adapter (25).

06. Install a new gasket (10) under the head of the previously removed Vernatherm®, install in the new engine adapter (27), torque to 300 in/lbs and secure with MS20995-C safety wire.

**Note D:** You must use the Bypass Valve Cap (26) if your aircraft uses an older Lycoming engine which does not utilize the newer type Lycoming P/N 53E22144 thermostatic bypass valve (Vernatherm) as your accessory case may not have been drilled by the Lycoming factory to utilize the Vernatherm.

07. Using small amount of silicone grease on oil filter gasket, install oil filter (18a), torque per instructions on oil filter, and secure with MS20995-C safety wire.
08. Run engine and check for leaks.
09. Determine weight and balance, initiate a 337 form, and update the equipment list.

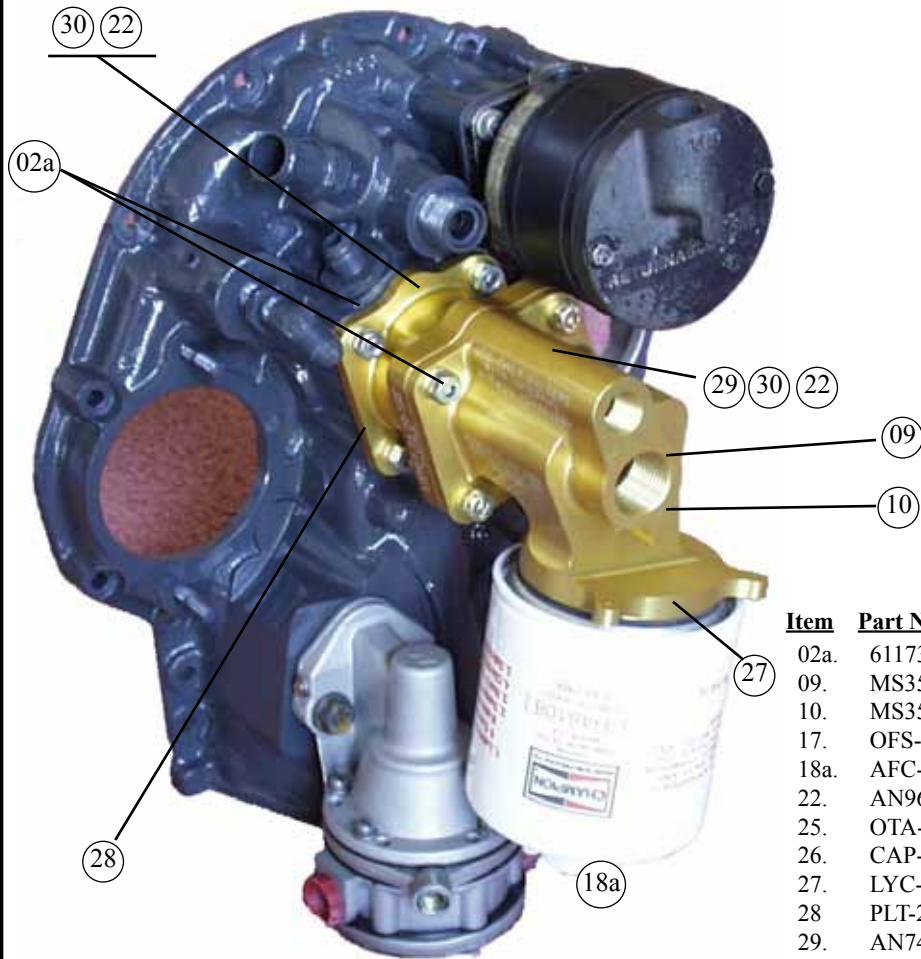

<u>Item</u>	<u>Part Number</u>	<u>Description</u>	<u>Qty</u>
02a.	61173	Adapter Base Gasket, O235-540	(1)
09.	MS35769-11	Gasket, Oil Temperature Sensor	(1)
10.	MS35769-21	Gasket, Thermostatic Valve	(1)
17.	OFS-10	Oil Filter Stud	(1)
18a.	AFC-500	Oil Filter	(1)
22.	AN960-416	1/4" Flat Washer	(8)
25.	OTA-527	Oil Temp Adapter (Opt)	
26.	CAP-1350	Bypass Valve Cap (Opt)	
27.	LYC-12	Full Flow Engine Adapter	(1)
28.	PLT-200	2" Adapter Plate	(1)
29.	AN74A-6	Drilled Head Bolts	(4)
30.	MS35333-40	1/4" Star Washer	(8)

# ASSEMBLY DRAWING# AFC-D-0025

## VERTICAL INSTALLATION

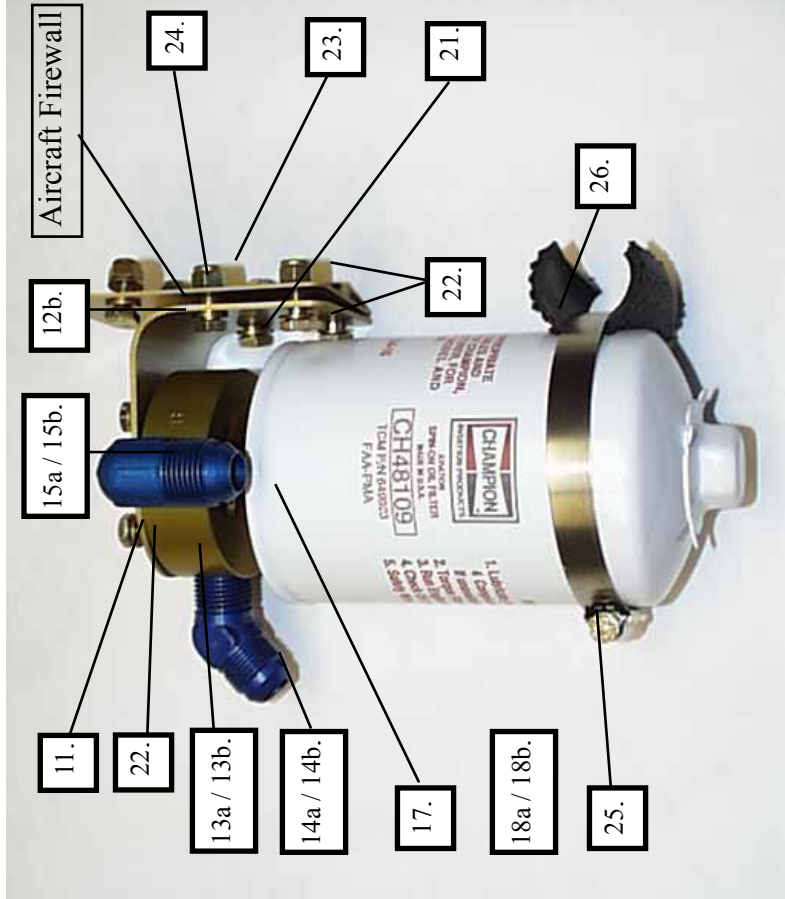

### MATERIAL LIST

Index	Part Number	Description	Qty
11.	AN4H-4A	Bolts, Drilled Head	(4)
12b.	OFM-11	Vertical Oil Filter Mount Plate	(1)
13a.	OFB-10	Oil Filter Base	(1)
13b.	OFB-11	Oil Filter Base, IO720	(1)
14a.	MS20822-8D	90° Fitting	1)
14b.	MS20822-10D	90° Fitting, IO720	(1)
15a.	MS20823-8D	45° Fitting	(1)
15b.	MS20823-10D	45° Fitting, IO720	(1)
16a.	AN816-8D	Union	(1)
16b.	AN816-10D	Union, IO720	(Opt)
17.	OFS-10	Oil Filter Stud	(Opt)
18a.	AFC-500	Oil Filter, Std.	(1)
18b.	AFC-600	Oil Filter, Long	(1)
21.	AN4-5A	Bolt	(6)
22.	AN960-416	Flat Washers	(16)
23.	MS20365-428A	Locknut	(6)
24.	DBL-10	Doubler Plate	(1)
25.	QS100M52H	Clamp	(1)
26.	MIL6000-1/2-2	Dampener	(1)

## HORIZONTAL INSTALLATION

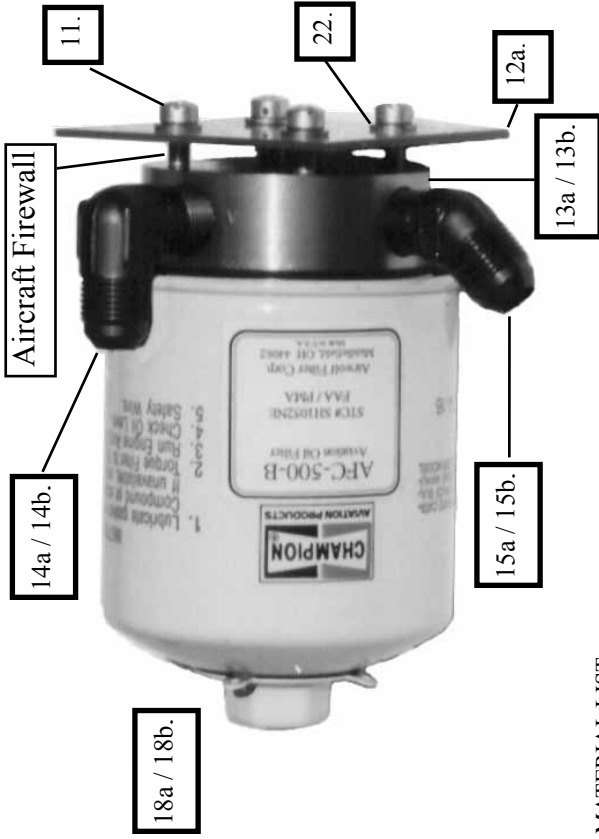

### MATERIAL LIST

Index	Part Number	Description	Qty
11.	AN4H-4A	Drilled Head Bolts	(4)
12a.	OFM-10	Horizontal Oil Filter Mount	(1)
13a.	OFB-10	Oil Filter Base	(1)
13b.	OFB-11	Oil Filter Base, IO720	(1)
14a.	MS20822-8D	90° Fitting	(1)
14b.	MS20822-10D	90° Fitting IO720	(1)
15a.	MS20823-8D	45° Fitting	(1)
15b.	MS20823-10D	45° Fitting IO720	(1)
16a.	AN816-8D	Union	(Opt)
16b.	AN816-10D	Union, IO720	(Opt)
17.	OFS-10	Oil Filter Stud	(1)
18a.	AFC-500	Oil Filter, Std.	(1)
18b.	AFC-600	Oil Filter, Long	(1)
22.	AN960-416	Flat Washers	(4)
24.	DBL-10	Doubler Plate	(1)

**Airwolf Filter Corp.**

Assembly Drawing:

OFM-10 Oil Filter Mount Plate - Horizontal,

OFM-11 Oil Filter Mount Plate - Vertical,

DBL-10 Doubler Plate & OFB-10 Oil Filter Base

# ASSEMBLY DRAWING# AFC-D-0026

## MATERIAL LIST

Index	Part Number	Description	Qty
01a.	LYC-10	Full Flow EngineAdapter, O235-540	(1)
01b.	LYC-11	Full Flow EngineAdapter, IO720	(1)
02a.	61173	Adapter Base Gasket O235-540	(1)
02b.	12777	Adapter Base Gasket, IO720, [Not Shown]	(1)
02c.	12776	Adapter Base Gasket, IO720, [Not Shown]	(1)
03a.	PLT-12775	Adapter Plate, IO720 [Not Shown]	(1)
03b.	PLT-12999	Restrictor Plate, O235 [Not Shown]	(1)
04a.	AN837-8D	45° Bulkhead Fitting	(2)
04b.	AN833-8D	90° Bulkhead Fitting	(Opt)
04c.	AN815-8D	Union	(Opt)
05a.	AN837-10D	45° Bulkhead Fitting, IO720	(2)
05b.	AN833-10D	90°Bulkhead Fitting, IO720	(Opt)
05c.	AN815-10D	Union, IO720	(Opt)
06a.	AN6289-8D	Bulkhead Nut	(2)
06b.	AN6289-10D	Bulkhead Nut, IO720	(2)
07a.	MS28773-08	Teflon Boss Gasket	(2)
07b.	MS28773-10	Teflon Boss Gasket, IO720	(2)
08a.	MS9387-08	Viton "O" Ring	(2)
08b.	MS9387-10	Viton "O" Ring, IO720	(2)
09.	MS35769-11	Oil Temperature Sensor Gasket	(1)
10.	MS35769-21	Vernatherm® Gasket	(1)

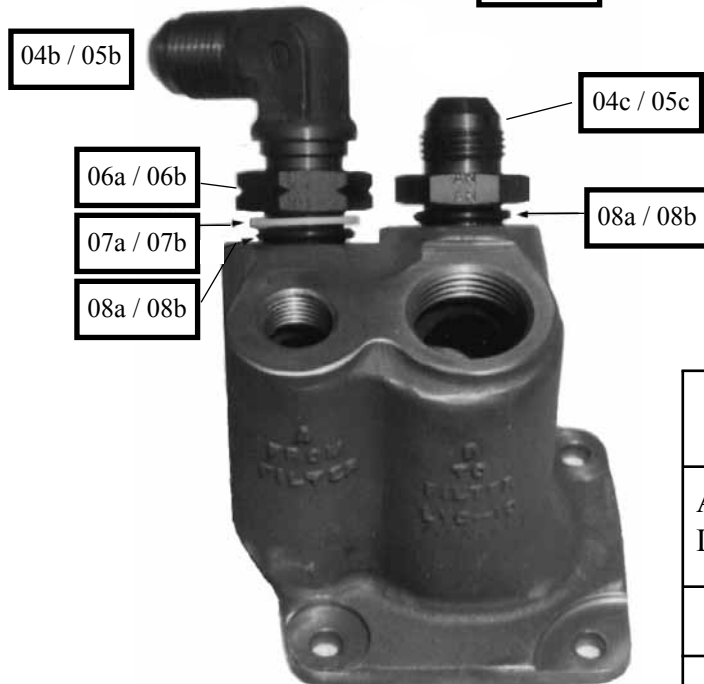
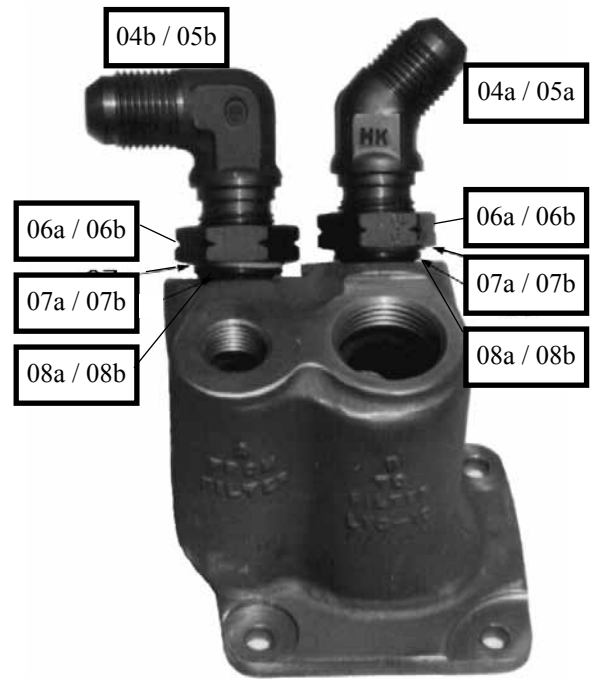
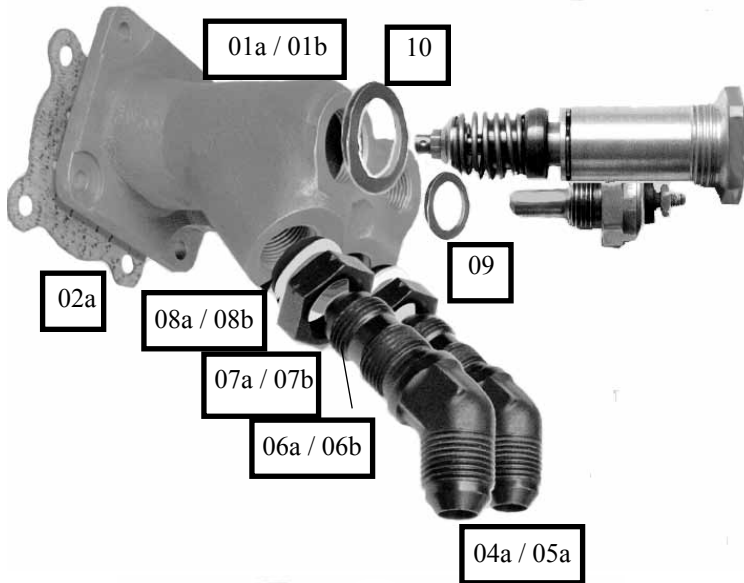

**Airwolf Filter Corp.**

Assembly Drawing.

LYC-10 Adapter, Engine - Full Flow

--	--	--	--

# ASSEMBLY DRAWING# AFC-D-0048

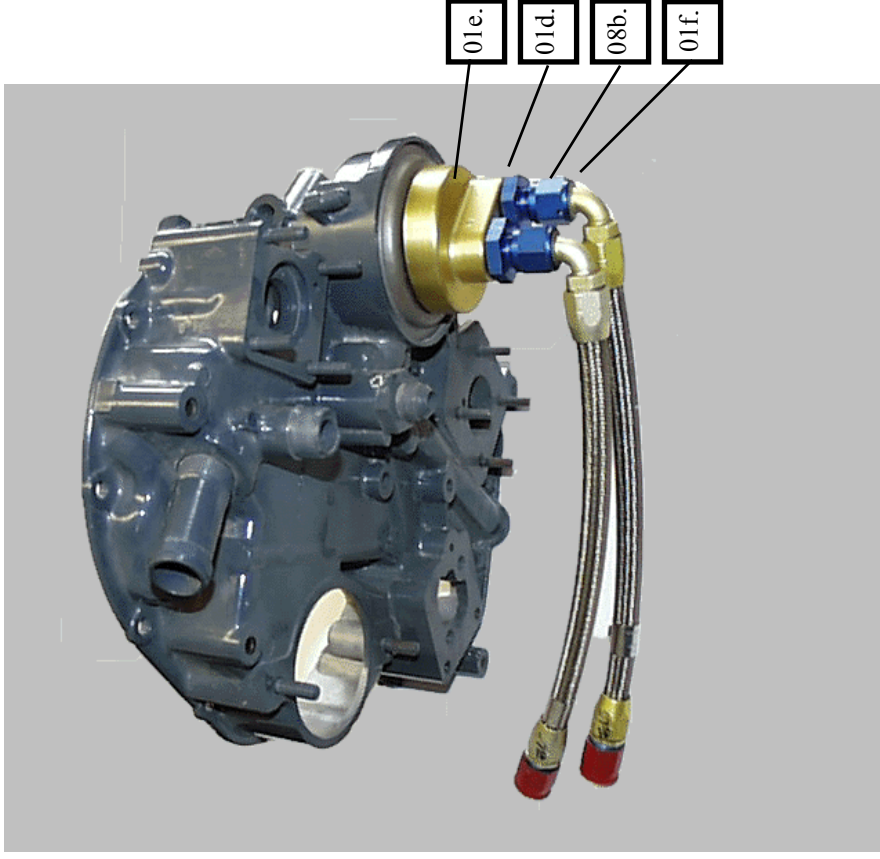
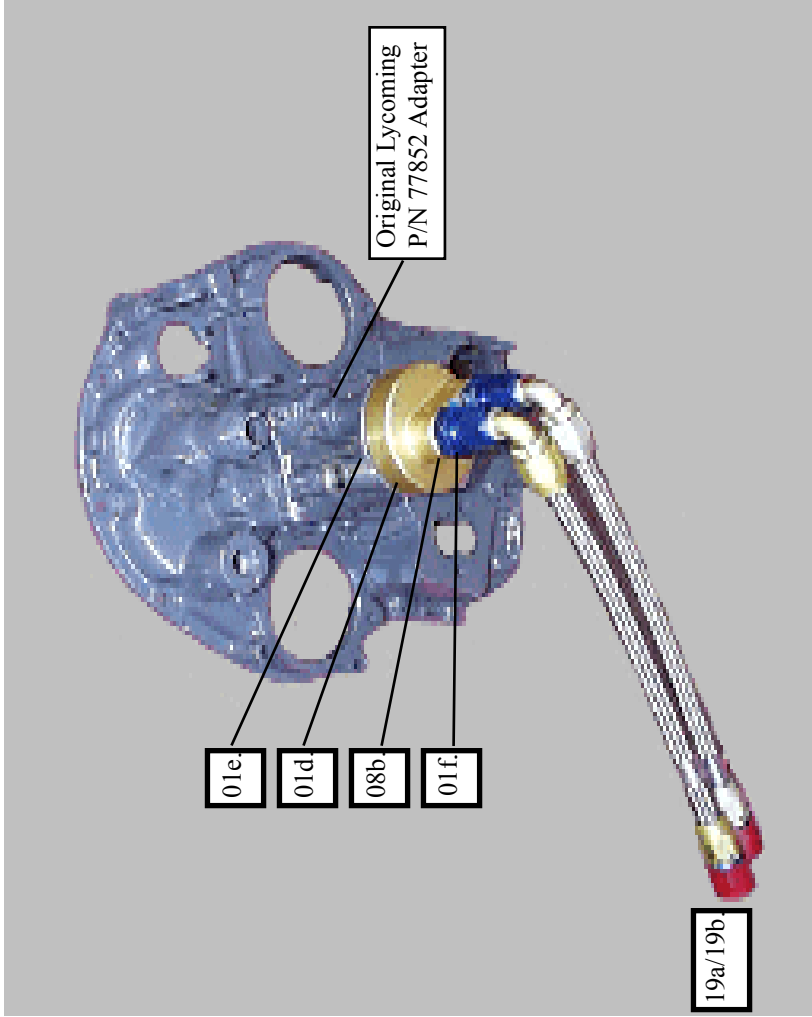

Quantity

- (1)
- (1)
- (2)
- (2)
- (Opt)

- Description
- Full Flow Engine Adapter-Single Drive Dual Mags [New Style]
  - Viton "O" Ring, Single Drive Dual Mags [New Style]
  - Reducer Fittings, -10 -> -8 Single Drive Dual Mags [New Style]
  - Viton "O" Rings, IO720
  - Titeflex® Firesleeved Teflon Hose, [-8], O235-540

- Part Number
- OFB-17
  - M83248/1-230
  - AN919-15D-SP
  - MS9387-10
  - F13000008-0xxx

- Index
- 01d.
  - 01e.
  - 01f.
  - 08b.
  - 19a.

Airwolf Filter Corp.

Assembly Drawing.  
OFB-17 Adapter, Engine - Full Flow





**Reference Data**  
for  
**AFC-K007**  
for  
**STC SA00024NY**  
**Oil Filter Kit**  
**AFC-K007**

**Dated: 4/2/2021**

**Airwolf Filter, Corp**  
**12801 Hwy. 75 N.**  
**OKMULGEE, OK 74447**  
(918) 561-8696 Ph  
(918) 561-8695 Fx





## Table of Contents

<u>Section</u>	<u>Page</u>
List of Effective Pages.....	1
Table of Contents.....	2
STOP, To the Mechanic .....	3
Data Pertinent to all Installations .....	4
Warnings and Notes.....	5
Illustrated Parts – Diagram, Kits A, B, C, D, & F.....	6
Parts Listing- Kits A, B, C, D, & F.....	7
Installation Instructions – AFC-K007-II-A .....	8
Installation Instructions – AFC-K007-II-B .....	9
Installation Instructions – AFC-K007-II-C .....	10
Installation Instructions – AFC-K007-II-D .....	11
Installation Instructions – AFC-K007-II-F .....	12
Illustrated Parts – Diagram, and Parts List for Kit G.....	13
Installation Instructions – AFC-K007-II-G .....	14
Illustrated Parts – Diagram, and Parts List for Kit H.....	15
Installation Instructions – AFC-K007-II-H .....	16
Weight and Balance Worksheet .....	17
Installation Drawing AFC-D-0001 (LYC-12 Oil Filter Mount Plate - Installation) .....	18
Assembly Drawing AFC-D-0013 (OFB-17 Adapter – Engine Full Flow) .....	19
Assembly Drawing AFC-D-0019 (OFM-15 Oil Filter Mount Plate – Boeing Stearman Installation) .....	20
Assembly Drawing AFC-D-0024 (OFM-11 Oil Filter Mount Plate - Vertical Installation) .....	21
Assembly Drawing AFC-D-0025 (OFM-10 Oil Filter Mount Plate - Horizontal Installation) .....	22
Assembly Drawing AFC-D-0026 (LYC-10 Adapter – Engine Full Flow) .....	23



**READ THIS BEFORE INSTALLING OIL FILTER KITS, DATA PERTINENT TO ALL INSTALLATIONS**

**TO THE MECHANIC:**

This P/N AFC-K007 remote mount oil filter kit incorporates our STC approved for all Lycoming powered aircraft up to 450 hp. Single and multi-engine fixed wing aircraft having firewalls of .021" ASTM A527 galvanized or equivalent. The STC paperwork provided with this kit utilizes the approved model list (AML) system instituted by the FAA.

Upon installing this filter kit, you will need to fill out and file a 337 form for this installation referencing the P/N AFC- K007 kit and the STC# SA00024NY. If your aircraft is not listed on the AML, you will also need a field approval by your local FSDO for this installation. This is necessary until your aircraft is listed, a field approval is required. If you are unsure whether you need a field approval, please call us directly.

If you have any questions or concerns on this STC, please call Airwolf Filter Corp, which we will clarify the details. Personnel are very familiar with our filter kits and can address any concerns you may have on your installation.

Airwolf Filter Corp  
12801 Hwy 75 N.  
Okmulgee, OK 74447  
Phone: (918) 561-8696  
Fax: (918) 561-8695

After completion of the installation of this kit, place a copy of the instructions along with the ICA in the Aircraft records for maintenance and replacement parts identification.

## DATA PERTINENT TO ALL INSTALLATIONS

Prior to installing the filter kit on the aircraft, weigh the filter kit, add the weight of the hoses, and subtract the oil screen or oil filter adapter removed from the engine and determine the net weight being added to the aircraft for determining the weight and balance of the aircraft later. Once the filter kit is installed on the aircraft, if you choose to purchase the hoses from Airwolf, we will supply you with the Hoses specified in this STC. At the time of the order, we will need the flare – to - flare length of the hoses, and hose ends needed on each hose i.e.: Straight to Straight, Straight to 90°, Straight to 45°, etc. allowing for engine torque and vibration per AC43.13.

**If our instructions do not specifically say you can do something, assume that means you are not allowed to do it without our written approval.**

1. Review all installation data and written material before beginning.
2. Please inspect contents of kit and inventory components before beginning.
3. **Do not** over tighten the fittings on Adapters or housings. This can distort or crack housings, causing oil to leak.
4. It is **EXTREMELY** important that oil lines be routed properly in accordance with AC 43.13-1A & 2A Acceptable Methods and Practices. (see Tip below)
5. See Warnings and Notes contained in the instructions concerning routing of lines and the use of sealant on NPT fittings.

### **DO NOT USE TEFLON TAPE ON FITTINGS.**

6. The use of sealant on AN/Flared type fittings is not required, it is only required on NPT fittings.
7. When mounting Adapters use the supplied doublers for reinforcing mounting locations.
8. **BE PATIENT!!!** Take your time and you will see the results of your effort.

### **TIP**

#### **How to get correct length of hose**

Hose length is measured from flare to flare. Do not use a string or a tape measure but take a section of old garden hose. Touch one end of the garden hose to the tip of one fitting and touch the other end of the hose to the other fitting, that is the correct length of hose needed. The garden hose is trying to bend to its natural set, which is normally the extra needed for engine torque and vibration per AC43.13, Also, if you kink a garden hose, you are obviously going to kink an aircraft hose. Doing it this way allows you to snake a hose across the back of an engine and around obstacles and this will replicate exactly how the aircraft hose will fit.

Thank you for taking the time to read this.

## WARNINGS & NOTES

### \*\*\*\*\*WARNING (A) \*\*\*\*\*

USE LOCTITE® BRAND 567 TEFLON THREAD SEALANT BEFORE INSTALLATION OF FITTINGS. DO NOT ASSEMBLE FITTINGS INTO OIL FILTER BASE WITHOUT SEALANT OTHERWISE GALLING OF MATERIAL WILL RESULT.

### \*\*\*\*\* WARNING (B) \*\*\*\*\*

NO ROUTING OF FLAMMABLE FLUID LINES ABOVE EXHAUST SYSTEM, UNLESS FIRESLEEVED. INSTALLER IS RESPONSIBLE FOR INTER-RELATIONSHIP BETWEEN THIS AND OTHER ENGINE CHANGES (INCLUDING ACCESSORIES)

### \*\*\*\*\* WARNING (C) \*\*\*\*\*

THE USE OF PARTS AND COMPONENTS NOT INCLUDED IN THE KIT, IS NOT COVERED BY THE STC APPROVAL. ALWAYS REMEMBER THAT THE DIRTY OIL FROM THE ENGINE ENTERS THE OIL FILTER FROM THE OUTSIDE OF THE FILTER. THE CLEAN OIL EXITS THROUGH THE LARGE HOLE IN THE CENTER OF THE OIL FILTER AND RETURNS TO THE ENGINE.

### \*\*\*\*\* WARNING (D) \*\*\*\*\*

DO NOT, UNDER ANY CIRCUMSTANCES, CONNECT AN OIL COOLER THAT DOES NOT HAVE A THERMOSTATIC CONTROL VALVE, IN SERIES WITH OUR REMOTE MOUNT OIL FILTER KIT. OUR FILTER KIT IS A "FULL FLOW" OIL FILTERING SYSTEM WHICH MEANS ALL OF THE OIL IS FILTERED ALL OF THE TIME. DURING STARTUP ON A COLD DAY, THE COLD THICK OIL WILL PARTIALLY BYPASS A CH48108 OR CH48109 OIL FILTER UNTIL THE VISCOSITY DROPS AND THE THIN OIL CAN FLOW THROUGH THE FILTER MEDIA THEREBY ALLOWING OIL TO CIRCULATE IN THE ENGINE. IF AN OIL COOLER HAS NO THERMOSTATIC BYPASS BUILT INTO THE UNIT, WHEN THE OIL FILTER GOES INTO PARTIAL BYPASS, THIS THICK SLUG OF OIL WILL BE STOPPED, OR SEVERELY RESTRICTED AT THE OIL COOLER. ONE OF THREE THINGS WILL HAPPEN:

1. THE OIL COOLER WILL SEPARATE IN HALF.
2. THE OIL FILTER GASKET WILL FAIL AND/OR THE OIL FILTER WILL EXPLODE.
3. THE OIL HOSE WILL FAIL

ANY OF THE THREE SCENARIOS ABOVE WILL CAUSE COMPLETE LOSS OF OIL IN A SHORT PERIOD OF TIME.

### NOTE:

#### ALL O-235 & O-290 OPERATORS

ON LYCOMING O-235 & O-290 SERIES ENGINES, LYCOMING MADE A DIFFERENCE IN THE PRODUCTION OF THE REAR ACCESSORY CASES. THE OIL MUST BE METERED THRU A .070 HOLE IN THE OIL SCREEN HOUSING TO PREVENT ALL THE ENGINE OIL FROM DUMPING ONTO THE OIL PUMP IDLER GEARS INSTEAD OF THRU THE OIL SCREEN. IF A REMOTE FILTER IS INSTALLED, THE OIL PRESSURE WILL TEND TO FOLLOW THE THROTTLE. BY USING THIS ENCLOSED RESTRICTOR PLATE, YOU WILL NOT EXPERIENCE THIS PROBLEM. INSTALLATION IS AS FOLLOWS:

1. INSTALL NEW 61173 OR GT-61173 ADAPTER GASKET ON ACCESSORY CASE.
2. INSTALL LW-12999 OR PLT-12999 RESTRICTOR PLATE.
3. INSTALL NEW 61173 OR GT-61173 ADAPTER GASKET.
4. INSTALL LYC-10 ADAPTER.

### NOTE.

#### COMMON TO ALL INSTALLATIONS

SOME HOSES OR WIRES MAY HAVE TO BE REROUTED SO THE OIL FILTER ASSEMBLY WILL FIT INTO POSITION. REFERENCE AND MATERIAL PER AC 43.13-1B & 2A.

**Illustrated Parts List No. AFC-K007-PL, A, B, C, D, & F,**  
**Applicability: Lycoming Powered Single and Multi-Engine**  
**A- Fixed Wing Aircraft with O-235 - O-540 Engines.**  
**B- Fixed Wing Aircraft with Less than 450hp, using Single Drive Dual Mags.**  
**C- Fixed Wing Aircraft with IO-720 Engines.**  
**D- Fixed Wing Aircraft with GO/GSO/IGSO 435/480/540 Engines.**  
**F- Fixed Wing Aircraft with Less than 450hp**  
**Having firewalls of .021" ASTM A527 galvanized steel or equivalent.**

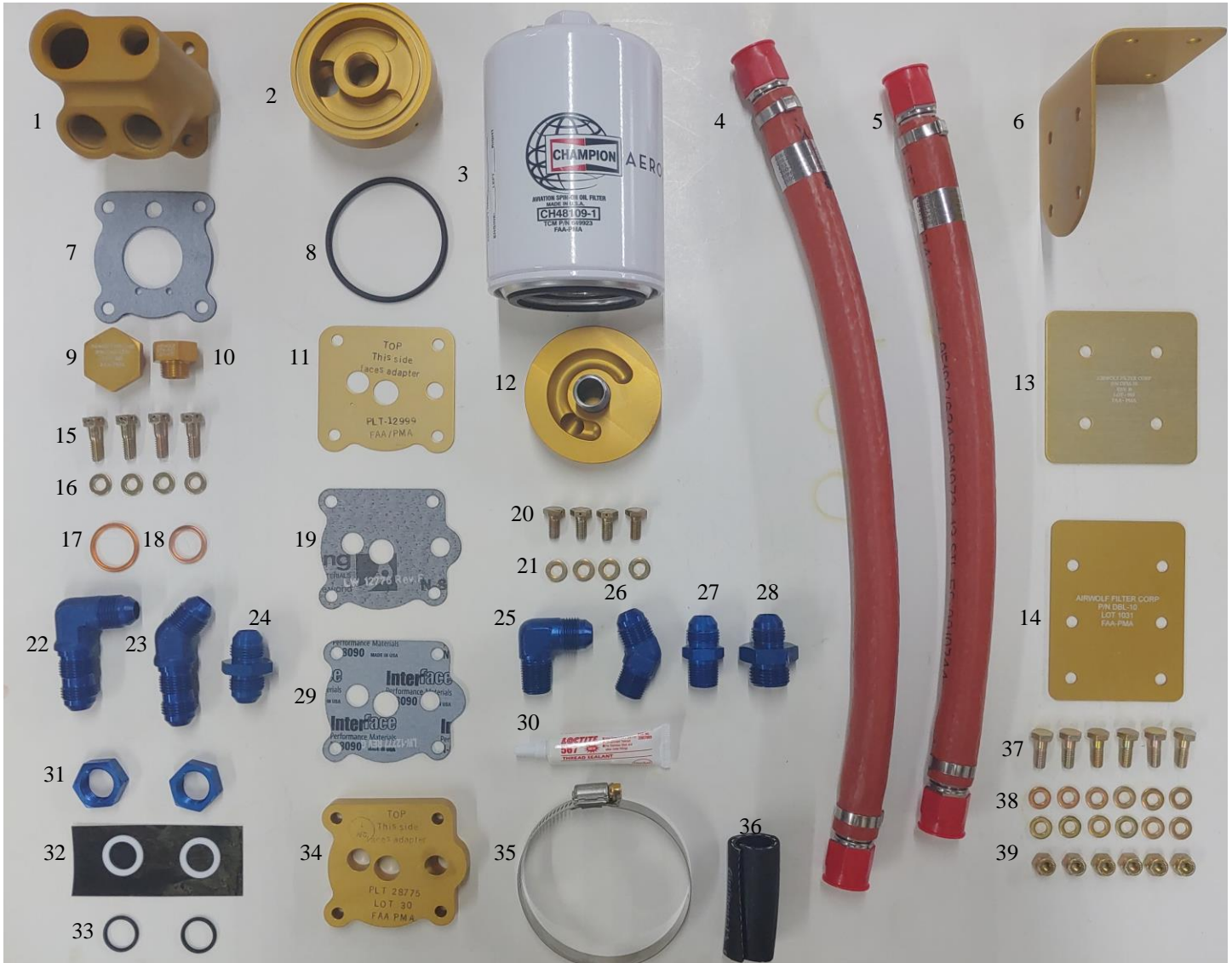

Parts Illustration Lycoming Engine Series

**Parts List No. AFC-K007-PL - Lycoming Engines**  
**(see Illustration)**  
**Lycoming Engine Series**

Index	Part Number	Description	Quantity
1	LYC-10	Adapter - Engine, Full Flow, All O-235 -540 except below	1
1	LYC-11	Adapter - Engine, Full Flow, IO-720	1
2	OFB-17	Full Flow Engine Adapter, Single Drive Dual Mags	1
3	AFC-500 or AFC-600	Oil Filter, or Equivalent [Champion CH48108/CH48109]	1
4	TBD	Fire sleeved Hose Assy, TSO'D,	1
5	TBD	Fire sleeved Hose Assy, TSO'D,	1
6	OFM-11	Oil Filter Mount Plate - 90°	1
7	61173 or equivalent	Gasket, Adapter Base, O-235-540	1
8	M83248/1-230	"O" Ring, Viton, Single Drive Dual Mags	1
9	CAP-1350	Bypass Valve Cap (opitonal)	1
10	OTA-527	Oil Temp Bulb Adapter	1
11	PLT-12999	Plate, Restrictor, O-235	1
12	OFB-10	Oil Filter Base, -8 Ports, O-235-540 (with OFS-10 Installed)	1
12	OFB-11	Oil Filter Base, -10 Ports, IO-720 (with OFS-10 Installed)	1
12	OFB-15	Oil Filter Base, -12 Ports, O235-540 (with OFS-10 Installed)	1
13	OFM-10	Horizontal Oil Filter Mount Plate	1
14	DBL-10	Plate, Doubler	1
15	AN74A-6	Bolt	4
16	AN960-416	Flat Washer	4
17	MS35769-21	Gasket, Thermostatic Valve	1
18	MS35769-11	Gasket, Oil Temperature Sensor	1
19	12776 or equivalent	Gasket, Adapter Base, IO-720	1
20	AN4H-4A	Bolt	4
21	AN960-416	Flat Washer	4
22	AN833-8D	Bulkhead Fitting 90°, O-235-540	Opt
22	AN833-10D	Bulkhead Fitting 90°, IO-720	Opt
23	AN837-8D	Bulkhead Fitting 45°, O-235-540	2
23	AN837-10D	Bulkhead Fitting 45°, IO-720	2
24	AN815-8D	Union, O-235-540	Opt
24	AN815-10D	Union, IO-720	Opt
25	MS20822-8D	Fitting, NPT to Flare - 90°, O-235-540	1
25	MS20822-10D	Fitting, NPT to Flare - 90°, IO-720	1
25	MS20822-12D	Fitting, NPT to Flare - 90°, GO/GSO/IGSO 435/480/540	1
25	AN842-16D	Fitting, NPT to Flare - 90°, W670	1
26	MS20823-8D	Fitting, NPT to Flare - 45°, O-235-540	1
26	MS20823-10D	Fitting, NPT to Flare - 45°, IO-720	1
26	MS20823-12D	Fitting, NPT to Flare - 45°, GO/GSO/IGSO 435/480/540	1
26	AN844-16D	Fitting, NPT to Flare - 45°, W670	1
27	AN816-8D	Nipple, NPT to Flare, O-235-540	Opt
27	AN816-10D	Nipple, NPT to Flare, IO-720	Opt
27	AN816-12D	Nipple, NPT to Flare, GO/GSO/IGSO 435/480/540	Opt
27	AN840-16D	Nipple, NPT to Flare, W670	Opt
28	AN919-15-SP	Fitting, Reducer, -10-8 Single Drive Dual Mags	2
29	12777 or equivalent	Gasket, Adapter Base, IO-720	1
30	567	Loctite Thread Sealant	1
31	AN6289-8D	Bulkhead Nut, O-235-540	2
31	AN6289-10D	Bulkhead Nut, IO-720	2
32	MS28773-08	Boss Gasket, O-235-540	2
32	MS28773-10	Boss Gasket, IO-720	2
33	M83248/1-908	Viton "O" Ring, O-235-540	2
33	M83248/1-910	Viton "O" Ring, IO-720	2
34	PLT-28775	Plate, Adapter, IO-720	1
35	QS100M52H	Clamp	1
36	MIL6000-3/4-2	Dampener, Vibration	1
37	AN4-5A	Bolt	6
38	AN960-416	Flat Washer	12
39	MS20365-428A	Locknut	6



Installation Instructions AFC-K007-II-A

**Applicability:** Lycoming Powered Single and Multi-Engine  
Fixed Wing Aircraft with O-235 – O-540 Engines.  
Having firewalls of .021" ASTM A527 galvanized steel or equivalent.

1. Remove the Lycoming P/N 69510, 68974 or 62815 engine oil screen housing from the accessory case.  
**\*\* WARNING - DO NOT REUSE OIL SCREEN IN LYC-10 ADAPTER \*\***
2. Remove oil temperature sensor and thermostatic valve from old oil screen housing.
3. As per Illustrated Parts List K007-PL - (A thru F), Install a new gasket (18) under the head of the oil temperature sensor, install in the adapter-engine (1). Turn the oil temp sensor until the sealing surfaces are in contact and then tighten an additional 135 degrees. Install a new gasket (17) under the head of the Lycoming P/N 75944 thermostatic valve, install in the adapter-engine (1), torque to 300 in/lbs. and secure. (See Drawing AFC-D-0026)

**Note A:** You must use the bypass valve Cap (9) if your aircraft uses an older Lycoming engine which does not utilize the newer type Lycoming P/N 53E22144 thermostatic bypass valve (vernatherm) as your accessory case may not have been drilled by the Lycoming factory to utilize the vernatherm.

**Note B:** If removing the 68974 or 62815 oil screen housing from your engine which uses the older type capillary tube oil temperature probe and you intend to reuse this probe in our LYC-10 Adapter, it may be necessary to use our Oil Temp Adapter (10).

4. As per Illustrated Parts List K007-PL - (A thru F), Onto each bulkhead fitting (22) or (23), install in order 1 ea. bulkhead nut (31), boss gasket (32), and "O" Ring (33). If using union (24), use only "O" Ring (33). Install each completed assembly into the adapter-engine (1). (See Drawing AFC-D-0026)  
**BE CAREFUL:** O-ring and boss gasket must seal in the smooth area between the threaded areas of the bulkhead fitting.

**Note C:** Any combination of fittings (22), (23), or (24) is acceptable.

5. As per Illustrated Parts List K007-PL - (A thru F), Install a new gasket (7) on base of adapter-engine (1) and install onto the engine accessory case. Torque to specifications 96 in/ lbs. On O-235 Series engines, a restrictor plate (11) must be used to keep the engine oil pressure from following the throttle. Install as pictured using 1 ea. adapter base gasket (7) on each side of the restrictor plate.
6. As per Illustrated Parts List K007-PL - (A thru F), Using the horizontal oil filter mount (13) or vertical oil filter mount (6) as a drilling template, locate and drill mounting holes using a letter "F" drill.
- 7a. As per Illustrated Parts List K007-PL - (A thru F), Secure oil filter mount plate - vertical (6) to Fwd. side of firewall and doubler plate (14) to Aft side of firewall using bolts (37), washers (38), and nuts (39). (See Drawing AFC-D-0024)
- OR**
- 7b. As per Illustrated Parts List K007-PL - (A thru F), Secure oil filter base (12) to Fwd. side of firewall and horizontal oil filter mount plate (13) to rear side using bolts (20) and washers (21) and secure with .032 MS20995-C safety wire. (See Drawing AFC-D-0025)

**\*\*\*\*\* SEE WARNING (A) \*\*\*\*\***

8. As per Illustrated Parts List K007-PL - (A thru F), Install any combination of fitting (25), (26), or (27) into oil filter base (12). Mount to oil filter mount plate (6) or (13) using bolts (20), washers (21), and secure with .032 MS20995-C safety wire.

**\*\*\*\*\* SEE WARNING (B) \*\*\*\*\***

9. As per Illustrated Parts List K007-PL - (A thru F), Determine hose lengths (see Tip on page 4) and order appropriate length hoses (4) & (5). It is recommended that hoses be fire sleeved.
10. As per Illustrated Parts List K007-PL - (A thru F), Install assembled hose assy's (4) or (5) connecting the "A" port on the engine adapter to the "A" port on the filter base and the "B" port on the engine adapter to the "B" port on the filter base and torque to 270-350 in/ lbs.
11. Install oil filter (3) torque per instructions on oil filter, and secure with MS20995-C safety wire.
12. Run engine and check for leaks.
13. Determine weight and balance, initiate a 337 form, and update the equipment list.



Installation Instructions AFC -K007-II-B**Applicability:**

**Lycoming Powered Single and Multi-Engine  
Fixed Wing Aircraft using Single Drive Dual Magnetos.  
Having firewalls of .021" ASTM A527 galvanized steel or equivalent.**

1. Remove existing spin on oil filter from rear of accessory case.
2. Remove Champion P/N CH48212 Converter Stud from rear of accessory case.  
**DO NOT remove the Champion P/N CH48210 converter plate and gasket.**
3. Lubricate O-Ring (8) with Dow Corning DC-4 compound or equivalent. If unavailable, use engine oil. Install O-ring (8) into machined groove in oil filter adapter (2) and install onto the accessory case.
4. Per installation drawing AFC-D-0013, Place O-rings (33) onto fittings (28) and install into Engine Adapter (2).
5. Per installation drawing AFC-D-0013, Install assembled Engine Adapter (2) onto rear of accessory case. Torque to specifications 16-18 ft./lbs. and secure with .032 MS20995-C safety wire.
6. As per Illustrated Parts List K007-PL - (A thru F), Using the horizontal oil filter mount (13) or vertical oil filter mount (6) as a drilling template, locate and drill mounting holes using a letter "F" drill.
- 9a. As per Illustrated Parts List K007-PL - (A thru F), Secure oil filter vertical mount plate (6) to Fwd. side of firewall and doubler plate (14) to Aft side of firewall using bolts (37), washers (38), and nuts (39). (See Drawing AFC-D-0024)
- OR
- 9b. As per Illustrated Parts List K007-PL - (A thru F), Secure oil filter base (12) to Fwd. side of firewall and horizontal oil filter mount plate (13) to rear side using bolts (20) and washers (21) and secure with .032 MS20995-C safety wire. (See Drawing AFC-D-0025)
- \*\*\*\*\* SEE WARNING (A) \*\*\*\*\***
10. As per Illustrated Parts List K007-PL - (A thru F), Install any combination of fitting (25), (26), or (27) into oil filter base (12). Mount to oil filter mount plate (6) or (13) using bolts (20), washers (21), and secure with .032 MS20995-C safety wire.
- \*\*\*\*\* SEE WARNING (B) \*\*\*\*\***
11. As per Illustrated Parts List K007-PL - (A thru F), Determine hose lengths (see Tip on page 4) and order appropriate length hoses (4) & (5). It is recommended that hoses be fire sleeved.
12. As per Illustrated Parts List K007-PL - (A thru F), Install assembled hose assy's (4) or (5) connecting the "A" port on the engine adapter to the "A" port on the oil filter base and the "B" port on the engine adapter to the "B" port on the oil filter base and torque to 270-350 in/ lbs.
13. Install oil filter (3), torque per instructions on oil filter, and secure with MS20995-C safety wire.
14. Run engine and check for leaks.
15. Determine weight and balance, initiate a 337 form, and update the equipment list.

Installation Instructions AFC -K007-II-C

**Applicability:** **Lycoming Powered Single and Multi-Engine  
Fixed Wing Aircraft with IO-720 Engines.  
Having firewalls of .021" ASTM A527 galvanized steel or equivalent.**

1. Remove the Lycoming P/N 73300 engine oil screen housing or P/N 77852 oil filter base assy. from the accessory case.  
**\*\* WARNING - DO NOT REUSE OIL SCREEN IN LYC-11 ADAPTER \*\***
2. Remove oil temperature sensor and thermostatic valve from old oil screen housing.
3. As per Illustrated Parts List K007-PL - (A thru F), Install a new gasket (18) under the head of the oil temperature sensor and install into adapter-engine (1). Turn the oil temp sensor until the sealing surfaces are in contact and then tighten an additional 135 degrees. Install a new gasket (17) under the head of the Lycoming P/N 75944 thermostatic valve, install in the adapter-engine (1), torque to 300 in/lbs. and secure. (See Drawing AFC-D-0026)
4. As per Illustrated Parts List K007-PL - (A thru F), Onto each bulkhead fitting (22) or (23), install in order 1 ea. bulkhead nut (31), boss gasket (32), and "O" Ring (33). If using union (24), use only "O" Ring (33). Install each completed assembly into the adapter-engine (1). (See Drawing AFC-D-0026)  
**BE CAREFUL:** O-ring and boss gasket must seal in the smooth area between the threaded areas of the bulkhead fitting.

**Note A:** Any combination of fittings (22), (23), or (24) is acceptable.

5. As per Illustrated Parts List K007-PL - (A thru F), Onto accessory case, install in order 1 ea. gasket (19), adapter plate IO-720 (34), adapter base gasket (29). Trim gaskets as necessary to assure oil flow returning to the engine (far RH hole) is not restricted and that there is a smooth flow from the gasket (19), adapter plate (34) and gasket (29). Install assembled adapter-engine (1) onto the engine accessory case and torque to specifications 96 in/lbs.
  6. As per Illustrated Parts List K007-PL - (A thru F), Using the oil filter horizontal mount (13) or vertical oil filter mount (6) as a drilling template, locate and drill mounting holes using a letter "F" drill.
  - 7a. As per Illustrated Parts List K007-PL - (A thru F), Secure vertical oil filter mount plate (6) to Fwd. side of firewall and doubler plate (14) to Aft side of firewall using bolts (37), washers (38), and nuts (39). (See Drawing AFC-D-0024)  
OR
  - 7b. As per Illustrated Parts List K007-PL - (A thru F), Secure oil filter base (12) to Fwd. side of firewall and horizontal oil filter mount plate (13) to rear side using bolts (20) and washers (21) and secure with .032 MS20995-C safety wire. (See Drawing AFC-D-0025)
- \*\*\*\*\* SEE WARNING (A) \*\*\*\*\***
8. As per Illustrated Parts List K007-PL - (A thru F), Install any combination of fitting (25), (26), or (27) into oil filter base (12). Mount to oil filter mount plate (13) or (6) using bolts (20), washers (21), and secure with .032 MS20995-C safety wire.
- \*\*\*\*\* SEE WARNING (B) \*\*\*\*\***
9. As per Illustrated Parts List K007-PL - (A thru F), Determine hose lengths (see Tip on page 4) and order appropriate length hoses (4) & (5). It is recommended that hoses be fire sleeved.
  10. As per Illustrated Parts List K007-PL - (A thru F), Install assembled hose assy's (4) or (5) connecting the "A" port on the A engine adapter to the "A" port on the filter base and the "B" port on the engine adapter to the "B" port on the filter base and torque to 270-350 in/ lbs.
  11. Install oil filter (3), torque per instructions on oil filter, and secure with MS20995-C safety wire.
  12. Run engine and check for leaks.
  13. Determine weight and balance, initiate a 337 form, and update the equipment list.

Installation Instructions AFC -K007-II-D**Applicability:**

**Lycoming Powered Single and Multi-Engine  
Fixed Wing Aircraft with GO/GSO/IGSO 435/480/540 Engines.  
Having firewalls of .021" ASTM A527 galvanized steel or equivalent.**

1. Gain access to the engine compartment.
2. Locate the scavenge oil hose connecting the scavenge oil pump to the oil cooler.
3. Locate and determine proposed oil filter location on firewall.
4. As per Illustrated Parts List K007-PL - (A thru F), Using the vertical oil filter mount (6) as a drilling template, locate and drill mounting holes using a letter "F" drill.
5. As per Illustrated Parts List K007-PL - (A thru F), Secure the vertical oil filter mount (6) to Fwd. side of firewall and doubler plate (14) to Aft side of firewall using bolts (37), washers (38), and nuts (39). (See Drawing AFC-D-0024)
- \*\*\*\*\* SEE WARNING (A) \*\*\*\*\***
6. As per Illustrated Parts List K007-PL - (A thru F), Install any combination of fitting (25), (26), or (27) into oil filter base (12). Mount to oil filter mount plate (6) or (13) using bolts (20), washers (21), and secure with .032 MS20995-C safety wire. (See Drawing AFC-D-0025)
- \*\*\*\*\* SEE WARNING (B) \*\*\*\*\***
7. As per Illustrated Parts List K007-PL - (A thru F), Determine hose lengths (see Tip on page 4) and order appropriate length hoses (4) & (5). It is recommended that hoses be fire sleeved.
8. As per Illustrated Parts List K007-PL - (A thru F), Install assembled hose assy's (4) or (5) connecting the outlet port on the scavenge oil pump to the "B" port on the oil filter base (12). Connect the outlet "A" port of the oil filter base (12) to the inlet of the oil cooler. Torque hoses to 270-350 in/ lbs.
9. Install oil filter (3) torque per instructions on oil filter, and secure with MS20995-C safety wire.
10. Run engine and check for leaks.
11. Determine weight and balance, initiate a 337 form, and update the equipment list.

**Installation Instructions AFC -K007-II-F**

**Applicability: Lycoming Powered Single and Multi-Engine  
Fixed Wing Aircraft less than 450hp Engines.  
Having firewalls of .021" ASTM A527 galvanized steel or equivalent.**

1. Remove existing spin-on oil filter and stud from Lycoming P/N 77852 Oil Filter Adapter.
2. As per Illustrated Parts List K007-PL - (A thru F), Screw OFB-17 oil filter adapter (2) completely into existing Lycoming P/N 77852 and see if both parts make contact. If any gap exists, measure the gap, add .187 to this dimension and trim the OFS-10 oil filter stud to this length. When trimmed to the correct length the OFB-17 (2) will contact the 77852 adapter without the "O"-ring installed in our OFB-17 adapter. (See Drawing AFC-D-0013)

**Note B: Lycoming has recently changed the number of threads inside their P/N 77852 adapter which can cause our OFS-10 stud to bottom out before the actual OFB-17 (2) contacts the adapter, requiring the trimming of our OFS-10 stud.**

3. As per Illustrated Parts List K007-PL - (A thru F), Apply liberal amount of Dow Corning DC-4 silicon grease to the M83248/1-230 O-Ring (8). Install the O-ring into machined groove in OFB- 17 Engine Adapter (2) and install onto Lycoming P/N 77852 Oil Filter Adapter. (See Drawing AFC-D-0013)
4. Torque OFB-17 adapter (2) at this time to specifications 16-18 ft./lbs. and secure with .032 MS20995-C safety wire.
5. As per Illustrated Parts List K007-PL - (A thru F), Place M83248/1-910 O-rings (33) onto AN919-15D-SP fittings (28) and install into OFB-17 oil filter adapter (2).
6. As per Illustrated Parts List K007-PL - (A thru F), Using the OFM-10 horizontal oil filter mount (13) or OFM-11 vertical oil filter mount (6) as a drilling template, locate and drill mounting holes using a letter "F" drill.
- 7a. As per Illustrated Parts List K007-PL - (A thru F), Secure OFM-11 vertical oil filter mount plate (6) to Fwd. side of firewall and DBL-10 doubler plate (14) to Aft side of firewall using AN4-5A bolts (37), AN960-416 washers (38), and MS20365-428A nuts (39) supplied. (See Drawing AFC-D-0024)
- OR
- 7b. As per Illustrated Parts List K007-PL - (A thru F), Secure OFB-10 oil filter base (12) to Fwd. side of firewall and OFM-10 horizontal oil filter mount plate (13) to rear side using AN4H-4A bolts (20) and AN960-416 washers (21) supplied and secure with .032 MS20995-C safety wire. (See Drawing AFC-D-0025)

**\*\*\*\*\* SEE WARNING (A) \*\*\*\*\***

8. As per Illustrated Parts List K007-PL - (A thru F), Install any combination of fitting (25), (26), or (27) into OFB-10 oil filter base (12). Mount to OFM-10 (13) or OFM-11 oil filter mount plate (6) using AN4H-4A bolts (20) and AN960-416 washers (21), and secure with .032 MS20995-C safety wire.

**\*\*\*\*\* SEE WARNING (B) \*\*\*\*\***

9. As per Illustrated Parts List K007-PL - (A thru F), Determine hose lengths (see Tip on page 4) and order appropriate length hoses (4) & (5). It is recommended that hoses be fire sleeved.
10. As per Illustrated Parts List K007-PL - (A thru F), Install assembled hose assy's (4) or (5) connecting the "A" port on the engine adapter to the "A" port on the oil filter base and the "B" port on the engine adapter to the "B" port on the oil filter base and torque to 270-350 in/ lbs.
11. Install AFC-500 or AFC-600 oil filter (3) and torque per instructions on oil filter, and secure with MS20995-C safety wire.
12. Run engine and check for leaks.
13. Determine weight and balance, initiate a 337 form, and update the equipment list

**Parts List No. AFC-K007-PL-G**

**Applicability:**

Installation of the remote oil filter kit on Boeing Model 75 series aircraft with Lycoming R-680 Radial engines.



Parts Illustration Lycoming R-680 Radial Engine

**Parts List No. AFC-K007-PL-G**

Index	Part Number	Description	Quantity
1	MIL-6000	Hose 1"	25
2	MIL-6000	Hose 1"	25
3	OFB-15	Oil Filter Base, -12, 9with OFS-10 Installed)	1
4	QS100M16H	Clamp, Hose , 1"	4
5	AN842-16D	Fitting, NPT to Hose, 90° Elbow	2
6	AFC-600	Oil Filter, or Equivalent [Champion CH48109]	1
7	AN960-416	Washer, Flat, 1/4"	4
8	AN4H-4A	Bolt, 1/4" x 1/2" Long	4
9	OFM-11	Oil Filter Mount, Vertical	1
10	DBL-10	Plate, Doubler	1
11	MS20365-428A	Nut, Locking	6
12	AN960-416	Washer, Flat, 1/4"	12
13	AN4-5A	Bolt, 1/4" X 5/8" Long	6
14	QS100M52H	Clamp, Hose , 3 - 1/4"	1
15	567	Loctite Thread Sealant	1
16	MIL-6000	Hose 3/4" x 2" Vibration Dampener	1

**Installation Instructions AFC -K007-II-G**

**Applicability:** Installation of the remote oil filter kit on Boeing Model 75 series aircraft with Lycoming R-680 Radial engines.

1. Remove left engine cowl (top and door) and bottom engine cowl.
  2. Drain oil (optional).
  3. Remove engine oil return line P/N A75N1-3004 (note this may be a length of 1" Mil 6000 hose). This line runs from the engine to the oil tank.
  4. Turn the AN842-16D on top of the oil tank to where it points to the engine primer mounted in the step.
  5. Remove the screw that goes through the end of the firewall stiffener P/N 75-2912. This is located on the left side of the firewall on the aft side. Loosen the screw that goes through the firewall stiffener and the tab welded on the fuselage. This screw is approximately 4-3/4" inboard of the removed screw. (see drawing AFC-D-0019). Drill the hole of the removed screw to 1/4" (.250).
  6. As per Illustrated Parts List K007-PL -G, Measure 3-9/16" out from a vertical line drawn from the C/L of the left engine mount studs. Using reinforcing plate P/N DBL-10 (10) as a template drill the other 5 holes 1/4" (.250). The previously drilled hole is the middle outboard hole. (see drawing AFC-D-0019).
  7. Slip reinforcement plate DBL-10 (10) between the firewall and stiffeners. The long side goes up. (see drawing AFC-D-0024).
  8. Bolt oil filter base support angle P/N OFM-11 to firewall and reinforcement plate using (6ea) provided AN 4-5A bolts (see drawing AFC-D-0024) (see drawing AFC-D-0019).
- \*\*\*\*\* SEE WARNING (A) \*\*\*\*\***
9. As per Illustrated Parts List K007-PL -G, Install provided AN842-816D fittings (5) in the oil filter base. The fitting in B port points horizontal with the filter base. The other points over the first fitting.
  10. As per Illustrated Parts List K007-PL -G, Bolt oil filter base OFB-15 (3) to Vertical Filter Mount Plate OFM-11(9) using provided AN4H-4A bolts (8) and Washers AN960-416 (7). Oil inlet port "B" on the oil filter base is positioned to the front of the aircraft. Secure bolts with safety wire (see drawing AFC-D-0019).
  11. As per Illustrated Parts List K007-PL -G, install one 25" piece of 1" Mil 6000H hose (1) using provided QS100M16H hose clamps (4). The "B" port on the oil filter base is the oil inlet and comes from the outlet of the scavenge oil pump. The "A" port is the outlet of the oil filter base is the return line to the top of the oil tank. Tighten clamps.
  12. Install oil filter (6) torque per instructions on oil filter, and secure with MS20995-C safety wire.
  13. As per Illustrated Parts List K007-PL -G, Using the 2" piece of 3/4" Mil 6000 hose (16) provided, secure to bottom of oil filter with QS100M52H Clamp, 3-3/4" (14) and locate between bottom of oil filter and existing firewall. This will strengthen the oil filter mount and dampen the vibrations of the engine.
  14. Safety wire drain and refill oil tank with 4.4 gals. oil. (If step #2 is omitted this step is not necessary).
  15. Run engine and check for leaks.
  16. Determine weight and balance, initiate 337 form, and update the equipment list.

**\*\*\*\*\* NOTE OF CAUTION \*\*\*\*\***

**NEVER, EVER INSTALL AN OIL FILTER ON THE ENGINE OIL PUMP INLET. THE OIL LINES CAN COLLAPSE, THERE BY STARVING THE ENGINE OF OIL.**

**THE OIL ROUTING AND OIL FLOW IS ALWAYS.**

**ENGINE SCAVENGE PUMP OUTLET -TO- AIRWOLF OIL FILTER -TO- OIL COOLER [if applicable] -TO- OIL TANK.**



Parts List No. AFC-K007-PL-H

**Applicability:**

**Lycoming Powered Single and Multi-Engine  
Fixed Wing Aircraft less than 450hp Engines.  
Having firewalls of .021" ASTM A527 galvanized steel or equivalent.**

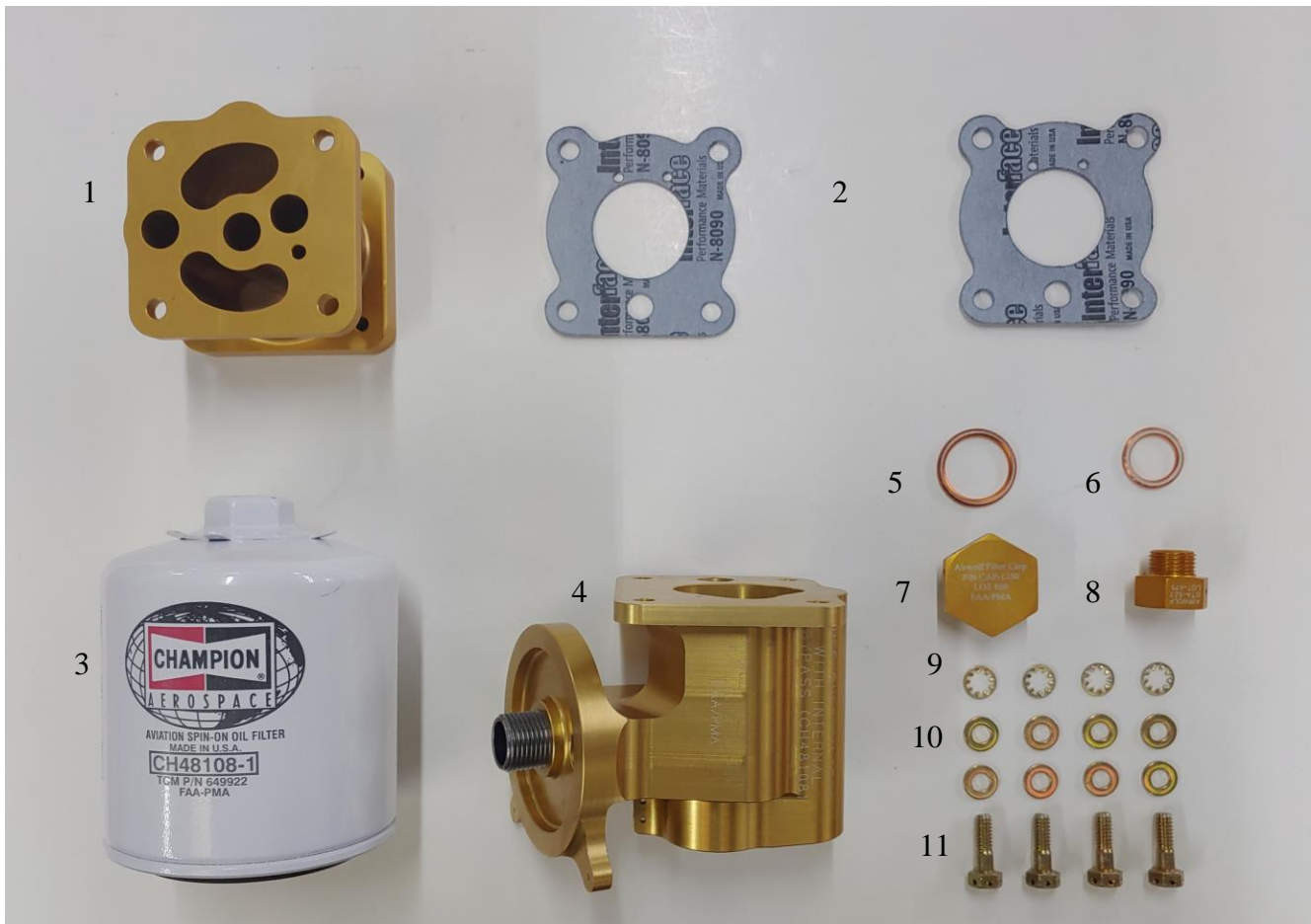

Parts Illustration Lycoming Engine

Parts List No. AFC-K007-PL-H

Index	Part Number	Description	Quantity
1	PLT-200	2" Adapter Plate	1
2	61173 or GT-61173	Gasket, Adapter Base, O-235-540	2
3	AFC-500	Filter, Oil	1
4	LYC-12	Adapter, Full Flow Engine (with OFS-10 Installed)	1
5	MS35769-21	Gasket, Thermostatic Valve	1
6	MS35769-11	Gasket, Oil Temperature Sensor	1
7	CAP-1350	Cap, Bypass Valve	Opt.
8	OTA-527	Adapter, Oil Temp	Opt.
9	MS35333-40	Washer, Star Locking, 1/4"	4
10	AN960-416	Washer, Flat 1/4"	8
11	AN74A-6	Bolts, Drilled Head	4



**Installation Instructions AFC -K007-II-H**

**Applicability: Lycoming Powered Single and Multi-Engine  
Fixed Wing Aircraft less than 450hp Engines.  
Having firewalls of .021" ASTM A527 galvanized steel or equivalent.**

1. Remove existing oil temperature probe and Vernatherm® [oil cooler bypass valve] from existing Lycoming P/N 77852 Spin-On Oil Filter Adapter or P/N 69510, 68974 or 62815 oil screen housing.
2. Remove existing spin on oil filter from Lycoming P/N 77852 Spin-On Oil Filter Adapter or P/N 69510, 68974 or 62815 oil screen housing from rear accessory case.

**Note A: See AFC-D-0001 Installation Drawing**

3. As per Illustrated Parts List K007-PL -G, Using Adapter Base Gasket (2) provided, install 2" Adapter Plate (1) onto rear accessory case using original nuts, washers, and lock washers, or supplied washers as needed and torque to 96 in/lbs.

**Note B: This Adapter Plate can only be positioned one way. Make sure holes in adapter match up with oil holes in accessory case.**

4. As per Illustrated Parts List K007-PL -G, Using Adapter Base Gasket (2) provided, install Full Flow Engine Adapter (4) onto newly installed 2" adapter plate (1) using drilled head bolts (9) and flat washers (8) provided, torque to 96 in/lbs., and secure with .032 MS20995-C safety wire.
5. As per Illustrated Parts List K007-PL -G, install a new gasket (6) under the head of the oil temperature sensor and install in the engine adapter (4). (If your temperature sensor is in a different location on the accessory case, use Lycoming P/N 62417 cap to plug off this hole.) Turn the oil temp sensor until the sealing surfaces are in contact and then tighten an additional 135 degrees.

**Note C: If removing the 68974 or 62815 oil screen housing from your engine which uses the older type capillary tube oil temperature probe and you intend to reuse this probe in our LYC-12 Adapter, it may be necessary to use our Oil Temp Adapter (8).**

6. As per Illustrated Parts List K007-PL -G, install a new gasket (5) under the head of the previously removed Vernatherm®, install in the engine adapter (4), torque to 300 in/ lbs. and secure with MS20995-C safety wire.

**Note D: You must use the bypass valve Cap (7) if your aircraft uses an older Lycoming engine which does not utilize the newer type Lycoming P/N 53E22144 thermostatic bypass valve (vernatherm) as your accessory case may not have been drilled by the Lycoming factory to utilize the vernatherm.**

7. Install oil filter (3), torque per instructions on oil filter, and secure with MS20995-C safety wire.
8. Run engine and check for leaks.
9. Determine weight and balance, initiate a 337 form, and update the equipment list.

**WEIGHT AND BALANCE REPORT**

<b>SURPLUS EQUIPMENT</b>	<b>WEIGHT</b>	<b>ARM-INCHES</b>		<b>MOMENT - IN/LBS.</b>	
<b>EQUIPMENT - ITEM</b>	<b>LBS.</b>	<b>LONG</b>		<b>LONG</b>	
REMOTE OIL FILTER	4.25				





**AIRWOLF FILTER CORP PROPRIETARY**

THIS DOCUMENT IS THE PROPERTY OF AIRWOLF FILTER CORP AND IS DELIVERED ON THE EXPRESS CONDITION THAT IT IS NOT TO BE DISCLOSED OR REPRODUCED IN WHOLE OR IN PART OR USED FOR MANUFACTURE FOR ANYONE OTHER THAN AIRWOLF FILTER CORP WITHOUT ITS WRITTEN CONSENT, AND THAT NO RIGHT IS GRANTED TO DISCLOSE OR SO USE ANY INFORMATION CONTAINED IN SAID DOCUMENT. THIS RESTRICTION DOES NOT LIMIT THE RIGHT TO USE INFORMATION OBTAINED FROM ANOTHER SOURCE.

**REVISIONS**

REV.	DESCRIPTION	BY	DATE

Part Number: AFC-K007

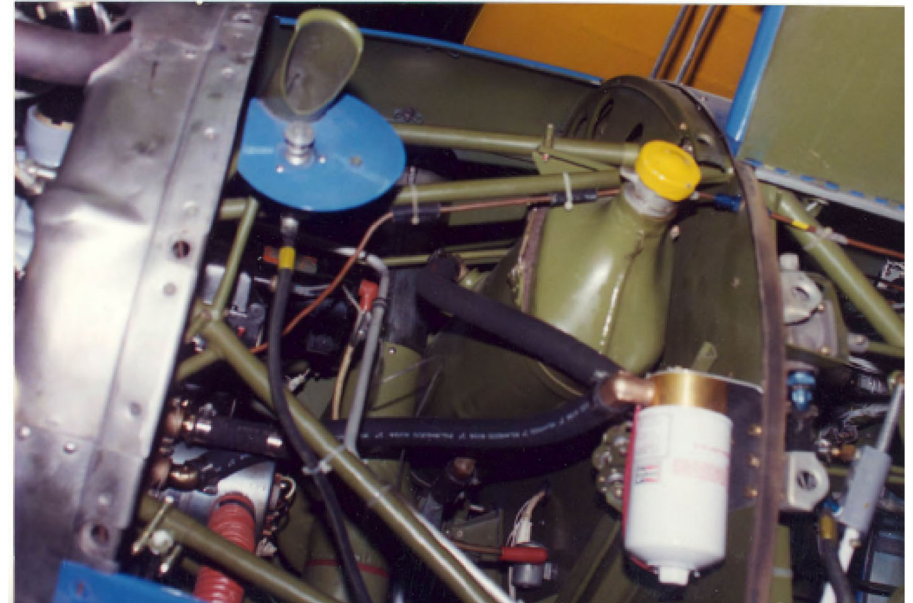
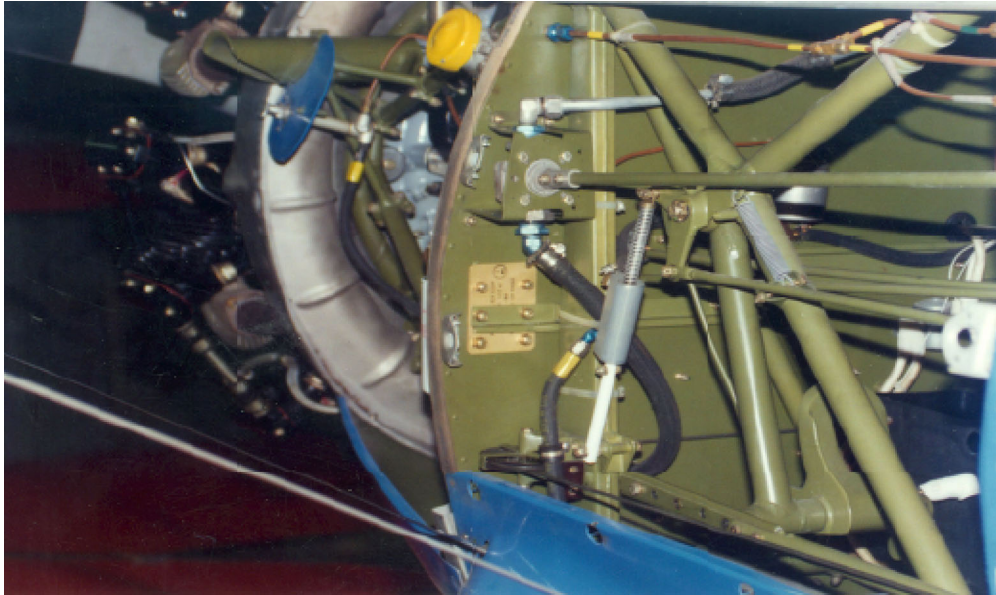

Page 20 of 23

		UNLESS OTHERWISE SPECIFIED:		NAME	DATE	<b>Airwolf Filter Corp.</b>		
		DIMENSIONS ARE IN INCHES TOLERANCES: 1 PLACE ±.030 2 PLACE ±.010 3 PLACE ±.005 4 PLACE ±.0005 ANGULAR ±0°30'	DRAWN	GM	12/8/2020			TITLE: <b>BOEING STEARMAN, OFM-15, Oil Filter Mount Plate</b>
			APPR. BY	BDA	12/8/2020			
			ENG APPR.					
			MFG APPR.					
		INTERPRET GEOMETRIC TOLERANCING PER: ANSY Y 14.5H	Q.A.			SIZE	DWG. NO.	REV
NEXT ASSY	USED ON	MATERIAL				<b>A</b>	<b>AFC-D-0019</b>	<b>IR</b>
APPLICATION		FINISH	COMMENTS:			SCALE:	WEIGHT:	SHEET 1 OF 1

5

4

3

2

1

Date: 4-2-2021



**AIRWOLF FILTER CORP PROPRIETARY**

THIS DOCUMENT IS THE PROPERTY OF AIRWOLF FILTER CORP AND IS DELIVERED ON THE EXPRESS CONDITION THAT IT IS NOT TO BE DISCLOSED OR REPRODUCED IN WHOLE OR IN PART OR USED FOR MANUFACTURE FOR ANYONE OTHER THAN AIRWOLF FILTER CORP WITHOUT ITS WRITTEN CONSENT, AND THAT NO RIGHT IS GRANTED TO DISCLOSE OR SO USE ANY INFORMATION CONTAINED IN SAID DOCUMENT. THIS RESTRICTION DOES NOT LIMIT THE RIGHT TO USE INFORMATION OBTAINED FROM ANOTHER SOURCE.

**REVISIONS**

REV.	DESCRIPTION	BY	DATE



MATERIAL LIST			
ITEM	PART NUMBER	DESCRIPTION	QTY.
1	AN4H-4A	BOLT, DRILLED HEAD	4
2	OFM-11	OIL FILTER MOUNT PLATE - 90°	1
3a	OFB-10	OIL FILTER BASE	1
3b	OFB-11	OIL FILTER BASE, IO720	1
4a	MS20823-8D	FITTING, 45°	1
4b	MS20823-10D	FITTING, 45°, IO720	1
5a	MS20822-8D	FITTING, 90°	1
5b	MS20822-10D	FITTING, 90°, IO720	1
6a	AN816-8D	UNION	OPT
6b	AN816-10D	UNION, IO720	OPT
7	OFS-10	OIL FILTER STUD	1
8a	AFC-500	OIL FILTER	1
8b	AFC-600	OIL FILTER, LONG	1
9	AN4-5A	BOLT	6
10	AN960-416	FLAT WASHER	16
11	MS20365-428A	LOCKNUT	6
12	DBL-10	DOUBLER PLATE	1
13	QS100M52H	CLAMP	1
14	MIL6000-3/4-2	DAMPENER	1

Part Number: AFC-K007

Date: 4-2-2021

UNLESS OTHERWISE SPECIFIED:		NAME	DATE	<b>Airwolf Filter Corp.</b>	
DIMENSIONS ARE IN INCHES		DRAWN	GM		
TOLERANCES:		APPR. BY	BDA	12/28/2020	TITLE: ASSEMBLY DRAWING, OFM-11 OIL FILTER MOUNT PLATE - VERTICAL, DBL-10 DOUBLER PLATE & OFB-10 or OFB-11 OIL FILTER BASE
1 PLACE ±.030		ENG APPR.			
2 PLACE ±.010		MFG APPR.			
3 PLACE ±.005		Q.A.			SIZE <b>A</b> DWG. NO. <b>AFC-D-0024</b> REV <b>IR</b>
4 PLACE ±.0005					
ANGULAR ±0°30'					SCALE:
INTERPRET GEOMETRIC TOLERANCING PER: ANSY Y 14.5H		COMMENTS:			WEIGHT:
MATERIAL					SHEET 1 OF 1
NEXT ASSY	USED ON				
APPLICATION					

5

4

3

2

1

**AIRWOLF FILTER CORP PROPRIETARY**

THIS DOCUMENT IS THE PROPERTY OF AIRWOLF FILTER CORP AND IS DELIVERED ON THE EXPRESS CONDITION THAT IT IS NOT TO BE DISCLOSED OR REPRODUCED IN WHOLE OR IN PART OR USED FOR MANUFACTURE FOR ANYONE OTHER THAN AIRWOLF FILTER CORP WITHOUT ITS WRITTEN CONSENT, AND THAT NO RIGHT IS GRANTED TO DISCLOSE OR SO USE ANY INFORMATION CONTAINED IN SAID DOCUMENT. THIS RESTRICTION DOES NOT LIMIT THE RIGHT TO USE INFORMATION OBTAINED FROM ANOTHER SOURCE.

**REVISIONS**

REV.	DESCRIPTION	BY	DATE
A	REDRAWN IN SOLIDWORKS	GM	12/28/2020

Part Number: AFC-K007

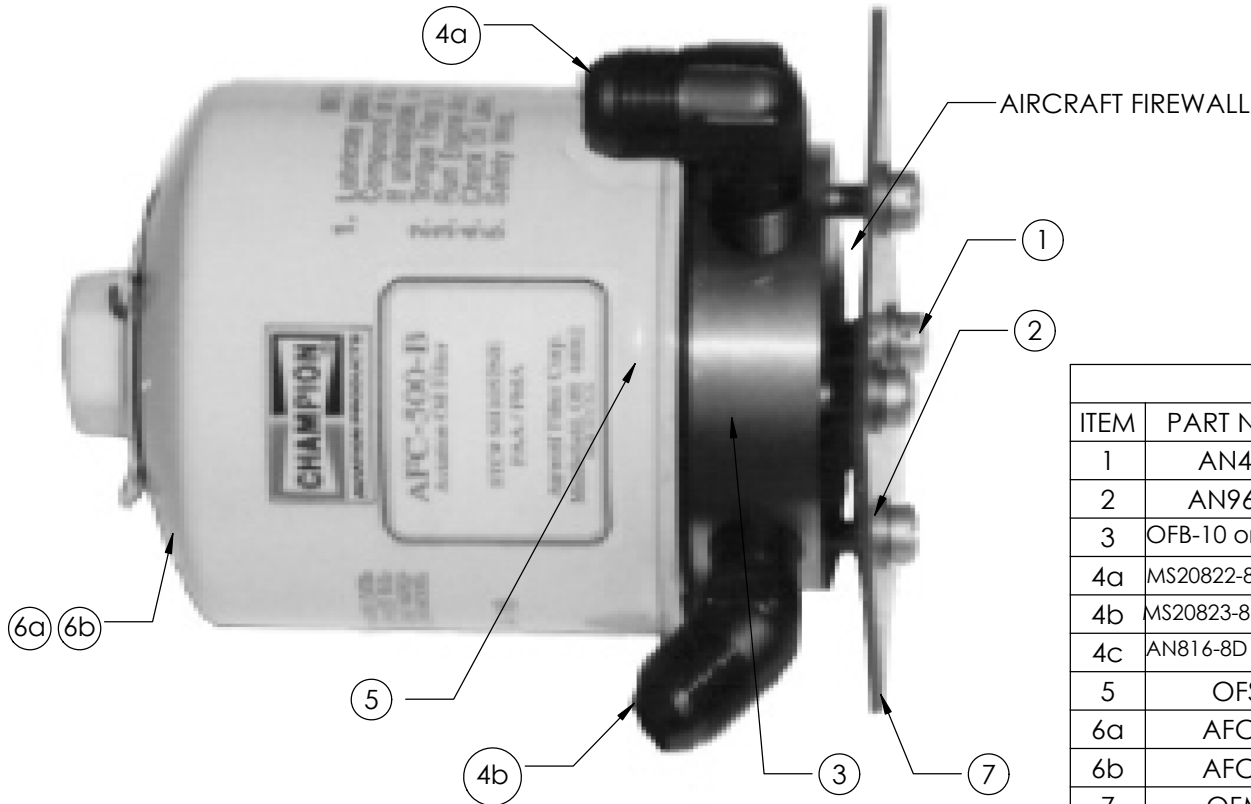

MATERIAL LIST			
ITEM	PART NUMBER	DESCRIPTION	QTY.
1	AN4H-4A	BOLT, DRILLED HEAD	4
2	AN960-416	FLAT WASHER	4
3	OFB-10 or OFB-11	OIL FILTER BASE	1
4a	MS20822-8D or -10D	FITTING, 90°	1
4b	MS20823-8D or -10D	FITTING, 45°	1
4c	AN816-8D or -10D	UNION	OPT
5	OFS-10	OIL FILTER STUD	1
6a	AFC-500	OIL FILTER	1
6b	AFC-600	OIL FILTER, LONG	1
7	OFM-10	OIL FILTER MOUNT PLATE	1

6a 6b

		UNLESS OTHERWISE SPECIFIED:	NAME	DATE
		DIMENSIONS ARE IN INCHES	DRAWN	GM
		TOLERANCES:	APPR. BY	BDA
		1 PLACE ±.030	ENG APPR.	
		2 PLACE ±.010	MFG APPR.	
		3 PLACE ±.005	Q.A.	
		4 PLACE ±.0005		
		ANGULAR ±0°30'		
		INTERPRET GEOMETRIC TOLERANCING PER: ANSY Y 14.5H		
		MATERIAL		
NEXT ASSY	USED ON	FINISH	COMMENTS:	
APPLICATION				

<b>Airwolf Filter Corp.</b>		
TITLE: ASSEMBLY DRAWING, OFM-10 OIL FILTER MOUNT PLATE - HORIZONTAL, & OFB-10 or -11 OIL FILTER BASE		
SIZE <b>A</b>	DWG. NO. <b>AFC-D-0025</b>	REV <b>A</b>
SCALE:	WEIGHT:	SHEET 1 OF 1

5 4 3 2 1

Date: 4-2-2021



**AIRWOLF FILTER CORP PROPRIETARY**

THIS DOCUMENT IS THE PROPERTY OF AIRWOLF FILTER CORP AND IS DELIVERED ON THE EXPRESS CONDITION THAT IT IS NOT TO BE DISCLOSED OR REPRODUCED IN WHOLE OR IN PART OR USED FOR MANUFACTURE FOR ANYONE OTHER THAN AIRWOLF FILTER CORP WITHOUT ITS WRITTEN CONSENT, AND THAT NO RIGHT IS GRANTED TO DISCLOSE OR SO USE ANY INFORMATION CONTAINED IN SAID DOCUMENT. THIS RESTRICTION DOES NOT LIMIT THE RIGHT TO USE INFORMATION OBTAINED FROM ANOTHER SOURCE.

**REVISIONS**

REV.	DESCRIPTION	BY	DATE
A	REDRAWN IN SOLIDWORKS	GM	12/28/2020

Part Number: AFC-K007

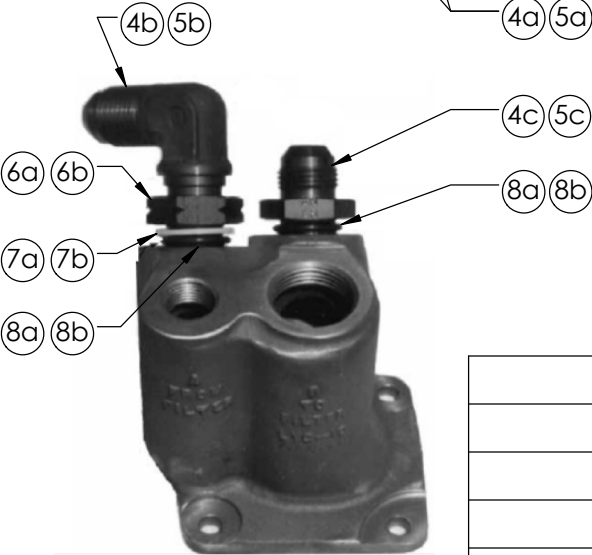
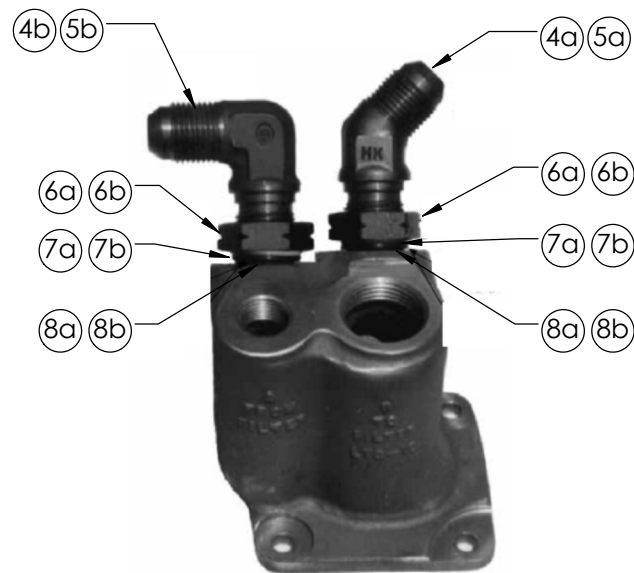
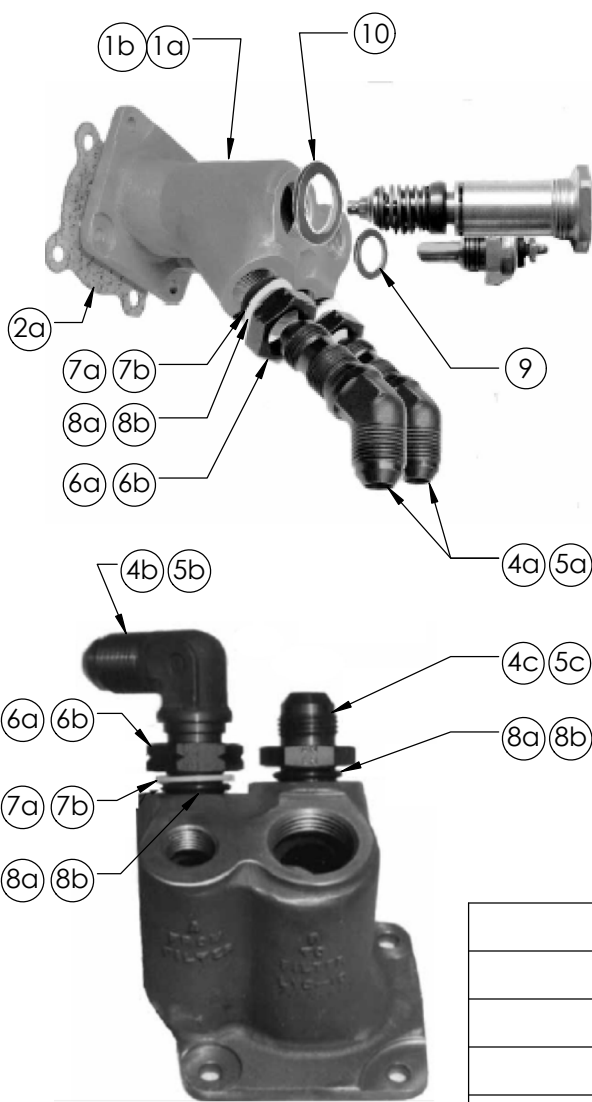

MATERIAL LIST			
ITEM	PART NUMBER	DESCRIPTION	QTY.
1a	LYC-10	FULL FLOW ENGINE ADAPTER, O235-540	1
1b	LYC-11	FULL FLOW ENGINE ADAPTER, O235-540	1
2a	61173 OR Equivalent	ADAPTER BASE GASKET, O235-540	1
2b	12777 OR Equivalent	ADAPTER BASE GASKET, IO720 (NOT SHOWN)	1
2c	12776 OR Equivalent	ADAPTER BASE GASKET, IO720 (NOT SHOWN)	1
3a	PLT-12775	ADAPTER PLATE, IO720 (NOT SHOWN)	1
3b	PLT-12999	RESTRICTOR PLATE, O235 (NOT SHOWN)	1
4a	AN837-8D	45° BULKHEAD FITTING	2
4b	AN833-8D	90° BULKHEAD FITTING	OPT
4c	AN815-8D	UNION	OPT
5a	AN837-10D	45° BULKHEAD FITTING, IO720	2
5b	AN833-10D	90° BULKHEAD FITTING, IO720	OPT
5c	AN815-10D	UNION, IO720	OPT
6a	AN6289-8D	BULKHEAD NUT	2
6b	AN6289-10D	BULKHEAD NUT, IO720	2
7a	MS28773-08	TEFLON BOSS GASKET	2
7b	MS28773-10	TEFLON BOSS GASKET, IO720	2
8a	M83248/1-908	VITON "O" RING	2
8b	M83248/1-910	VITON "O" RING, IO720	2
9	MS35769-11	OIL TEMPERATURE SENSOR GASKET	1
10	MS35769-21	VERNATHERM® GASKET	1

Page 23 of 23

		UNLESS OTHERWISE SPECIFIED:	NAME	DATE
		DIMENSIONS ARE IN INCHES	DRAWN	GM
		TOLERANCES:	APPR. BY	BDA
		1 PLACE ±.030	ENG APPR.	
		2 PLACE ±.010	MFG APPR.	
		3 PLACE ±.005	Q.A.	
		4 PLACE ±.0005		
		ANGULAR ±0°30'		
		INTERPRET GEOMETRIC TOLERANCING PER: ANSY Y 14.5H		
		MATERIAL		
NEXT ASSY	USED ON	FINISH	COMMENTS:	
APPLICATION				

<b>Airwolf Filter Corp.</b>		
TITLE: <b>ASSEMBLY DRAWING, LYC-10 ADAPTER, ENGINE - FULL FLOW</b>		
SIZE <b>A</b>	DWG. NO. <b>AFC-D-0026</b>	REV <b>A</b>
SCALE:	WEIGHT:	SHEET 1 OF 1

5

4

3

2

1

Date: 4-2-2021

**FAA APPROVED MODEL LIST (AML) SA00024NY**

**AIRWOLF FILTER CORP  
FOR INSTALLING  
REMOTE MOUNT OIL FILTER KIT**

ITEM	AIRCRAFT MAKE	AIRCRAFT MODEL	ORIGINAL TYPE CERTIFICATE NUMBER	CERTIFICATION BASIS FOR ALTERATION	INSTALLATION INSTRUCTIONS		AML AMENDMENT DATE
					NUMBER	REVISION NO. AND DATE	
1	AD AEROSPACE INC. (Thorp)	T-11	A-791	CAR PART 3 and Amendments Listed in TCDS No. A-791	AFC-K007	C 11/11/2010*	10/3/2012
2	AERMACCHI S.p.A.	S.205-18/F, S.205-18/R, S.205-20/F, S.205-20/R, S.208, S.208A	A9EU	14 CFR PART 23 and Amendments Listed in TCDS No. A9EU	AFC-K007	C 11/11/2010*	10/3/2012
3	AERMACCHI S.p.A.	F.260, F.260B, F.260C, F.260D, F.260E, F.260F	A10EU	CAR PART 3 and 14 CFR PART 23 and Amendments Listed in TCDS No. A10EU	AFC-K007	C 11/11/2010*	10/3/2012
4	AEROSTAR AIRCRAFT CORPORATION (Piper, Ted Smith)	PA-60-600 (Aerostar 600), PA-60-601 (Aerostar 601), PA-60-601P (Aerostar 601P), PA-60-602P (Aerostar 602P), PA-60-700P (Aerostar 700P)	A17WE	14 CFR PART 23 and Amendments Listed in TCDS No. A17WE	AFC-K007	C 11/11/2010*	11/25/1995
5	AEROTEK II INC (Aero Commander, Airplane Services, Call Air Intermountain, SL Industries)	B-1	A7WE	CAR PART 8.10(a)(1) and Amendments Listed in TCDS No. A7WE	AFC-K007	C 11/11/2010*	10/3/2012
6	AEROTEK II INC (Aero Commander, Airplane Services, Call Air Intermountain, SL Industries)	B-1	A8WE	CAR PART 3 and Amendments Listed in TCDS No. A8WE	AFC-K007	C 11/11/2010*	10/3/2012
7	AGUSTA S.p.A.	S.210	A25EU	14 CFR PART 23 and Amendments Listed in TCDS No. A25EU	AFC-K007	C 11/11/2010*	10/3/2012
8	ALEXANDRIA AIRCRAFT LLC (Bellanca)	14-19, 17-31, 17-31TC	1A3	14 CFR PART 23 and Amendments Listed in TCDS No. 1A3	AFC-K007	C 11/11/2010*	10/3/2012
9	ALEXANDRIA AIRCRAFT LLC (Bellanca)	17-31A, 17-31ATC	A18CE	14 CFR PART 23 and Amendments Listed in TCDS No. A18CE	AFC-K007	C 11/11/2010*	02/05/1996

**FAA APPROVED MODEL LIST (AML) SA00024NY**

**AIRWOLF FILTER CORP  
FOR INSTALLING  
REMOTE MOUNT OIL FILTER KIT**

ITEM	AIRCRAFT MAKE	AIRCRAFT MODEL	ORIGINAL TYPE CERTIFICATE NUMBER	CERTIFICATION BASIS FOR ALTERATION	INSTALLATION INSTRUCTIONS		AML AMENDMENT DATE
					NUMBER	REVISION NO. AND DATE	
10	ALPHA AVIATION CONCEPT LIMITED (Robin)	R2160	A48EU	14 CFR PART 23 and Amendments Listed in TCDS A48EU	AFC-K007	C 11/11/2010*	10/3/2012
11	AMERICAN CHAMPION AIRCRAFT CORP (Bellanca, Champion)	7ECA, 7GC, 7GCA, 7GCAA, 7GCB, 7GCBA, 7GCBC, 7HC, 7KC, 7KCAB	A-759	CAR PART 4a and CAR PART 8.10(b) and Amendments Listed in TCDS No. A-759	AFC-K007	C 11/11/2010*	05/25/1994
12	AMERICAN CHAMPION AIRCRAFT CORP (Bellanca, Champion)	8KCAB, 8GCBC	A21CE	14 CFR PART 23 and Amendments Listed in TCDS No. A21CE	AFC-K007	C 11/11/2010*	11/04/1993
13	APEX AIRCRAFT	R 3000/160	A66EU	14 CFR PART 23 and Amendments Listed in TCDS No. A66EU	AFC-K007	C 11/11/2010*	10/3/2012
14	APEX AIRCRAFT (Avion Mundry)	CAP 10B	A36EU	14 CFR PART 23 and Amendments Listed in TCDS No. A36EU	AFC-K007	C 11/11/2010*	10/3/2012
15	ARIZONA AEROSPACE FOUNDATION (Taylorcraft)	DL-65	A-746	CAR PART 4a and Amendments Listed in TCDS No. A-746	AFC-K007	C 11/11/2010*	10/3/2012
16	AUGUSTAIR, INC. (Varga, Morrisey)	2150, 2150A, 2180	4A19	CAR PART 3and Amendments Listed in TCDS No. 4A19	AFC-K007	C 11/11/2010*	10/3/2012
17	AUGUSTA S.p.A.	S.210	A25EU	14 CFR PART 23 and Amendments Listed in TCDS No. A25EU	AFC-K007	C 11/11/2010*	10/3/2012
18	B-N GROUP LTD. (Britten Norman)	BN2A MK III, BN2A MK III-2, BN2A MK III-3	A29EU	14 CFR PART 23 and Amendments Listed in TCDS No. A29EU	AFC-K007	C 11/11/2010*	10/3/2012



**FAA APPROVED MODEL LIST (AML) SA00024NY**  
**AIRWOLF FILTER CORP**  
**FOR INSTALLING**  
**REMOTE MOUNT OIL FILTER KIT**

ITEM	AIRCRAFT MAKE	AIRCRAFT MODEL	ORIGINAL TYPE CERTIFICATE NUMBER	CERTIFICATION BASIS FOR ALTERATION	INSTALLATION INSTRUCTIONS		AML AMENDMENT DATE
					NUMBER	REVISION NO. AND DATE	
19	<b>B-N GROUP LTD.</b> (Britten Norman, Pilatus)	BN-2, BN-2A, BN-2A-2, BN-2A-3, BN-2A-6, BN-2A-8, BN-2A-9, BN-2A-20, BN-2A-21, BN-2A-26, BN-2A-27, BN-2B-20, BN-2B-21, BN-2B-26, BN-2B-27	A17EU	14 CFR PART 23 and Amendments Listed in TCDS No. A17EU	AFC-K007	C 11/11/2010*	10/3/2012
20	<b>BOEING AIRPLANE CO</b> (Stearman)	A75L3, A75 (Army PT-13A, -13B, -13C), B75 (Navy N2S-5), E75 (Army PT-13D, Navy N2S-5), A75L-300, E75N1	A-743	CAR PART 4a and Amendments Listed in TCDS No. A-743	AFC-K007	C 11/11/2010	10/3/2012
21	<b>BOEING AIRPLANE CO</b> (Stearman)	75 (Army PT-13), A75N1 (Army PT-17, -17A, Navy N2S-1, -4), B75N1 (Navy N2S-3), D75N1 (Army PT-27), A75J1 (Army PT-18), IB75A, with Lycoming Engine STC	A-743	CAR PART 4a and Amendments Listed in TCDS No. A-743	AFC-K007	C 11/11/2010	10/3/2012
22	<b>CESSNA AIRCRAFT COMPANY</b>	120, 140 with optional or Lycoming Engine STC	A-768	CAR PART 4a and Amendments Listed in TCDS No. A-768	AFC-K007	C 11/11/2010*	05/15/1999
23	<b>CESSNA AIRCRAFT COMPANY</b>	152, A152	3A19	CAR PART 3and Amendments Listed in TCDS No. 3A19	AFC-K007	C 11/11/2010*	11/22/1994
24	<b>CESSNA AIRCRAFT COMPANY</b> (Reims Aviation SA)	F152, FA152	A13EU	CAR PART 3and Amendments Listed in TCDS No. A13EU	AFC-K007	C 11/11/2010*	10/3/2012
25	<b>CESSNA AIRCRAFT COMPANY</b>	172I, 172K, 172L, 172M, 172N, 172P, 172Q, 172R, 172S	3A12	CAR PART 3and 14 CFR PART 23 and Amendments Listed in TCDS No. 3A12	AFC-K007	C 11/11/2010*	11/22/1994
26	<b>CESSNA AIRCRAFT COMPANY</b> (Reims Aviation SA)	F172L, F172M, F172N, F172P	A4EU	CAR PART 10 and Amendments Listed in TCDS No. A4EU	AFC-K007	C 11/11/2010*	10/3/2012

**FAA APPROVED MODEL LIST (AML) SA00024NY**

**AIRWOLF FILTER CORP**

**FOR INSTALLING**

**REMOTE MOUNT OIL FILTER KIT**

ITEM	AIRCRAFT MAKE	AIRCRAFT MODEL	ORIGINAL TYPE CERTIFICATE NUMBER	CERTIFICATION BASIS FOR ALTERATION	INSTALLATION INSTRUCTIONS		AML AMENDMENT DATE
					NUMBER	REVISION NO. AND DATE	
27	CESSNA AIRCRAFT COMPANY	172RG,	3A17	CAR PART 3and Amendments Listed in TCDS No. 3A17	AFC-K007	C 11/11/2010*	05/15/1999
28	CESSNA AIRCRAFT COMPANY	177, 177A, 177B	A13CE	14 CFR PART 23 and Amendments Listed in TCDS No. A13CE	AFC-K007	C 11/11/2010*	02/03/1994
29	CESSNA AIRCRAFT COMPANY	177RG	A20CE	14 CFR PART 23 and Amendments Listed in TCDS No. A20CE	AFC-K007	C 11/11/2010*	10/3/2012
30	CESSNA AIRCRAFT COMPANY (Reims Aviation SA)	F177RG	A26EU	14 CFR PART 23 and Amendments Listed in TCDS No. A26EU	AFC-K007	C 11/11/2010*	10/3/2012
31	CESSNA AIRCRAFT COMPANY	FR182	A42EU	CAR PART 3and Amendments Listed in TCDS No. A42EU	AFC-K007	C 11/11/2010*	10/3/2012
32	CESSNA AIRCRAFT COMPANY	T182, T182T, R182, TR182, 182S, 182T	3A13	CAR PART 3and Amendments Listed in TCDS No. 3A13	AFC-K007	C 11/11/2010*	10/3/2012
33	CESSNA AIRCRAFT COMPANY	206H, T206H	A4CE	CAR PART 3and Amendments Listed in TCDS No. A4CE	AFC-K007	C 11/11/2010*	05/15/1999
34	CESSNA AIRCRAFT COMPANY	310Q Equipped with Lycoming L/TIO-540-J2BD Engines per STC SA2082WE	3A10	CAR PART 3and Amendments Listed in TCDS No. 3A10	AFC-K007	C 11/11/2010*	05/23/1997
35	COMMANDER PREMIER AIRCRAFT CORPORATION (Commander, Rockwell, CPAC INC.)	112, 112TC, 112B, 112TCA, 114, 114A, 114B, 114TC	A12SO	14 CFR PART 23 and Amendments Listed in TCDS No. A12SO	AFC-K007	C 11/11/2010*	10/3/2012
36	CONSOLIDATED-VULTEE AIRCRAFT CORP, STINSON DIVISION	L-5, L-5B, L-5C, L-5D, L-5E, L-5E-1, L-5G	A-764	CAR PART 4a and Amendments Listed in TCDS No. A-764	AFC-K007	C 11/11/2010*	11/22/1994



**FAA APPROVED MODEL LIST (AML) SA00024NY**

**AIRWOLF FILTER CORP  
FOR INSTALLING  
REMOTE MOUNT OIL FILTER KIT**

ITEM	AIRCRAFT MAKE	AIRCRAFT MODEL	ORIGINAL TYPE CERTIFICATE NUMBER	CERTIFICATION BASIS FOR ALTERATION	INSTALLATION INSTRUCTIONS		AML AMENDMENT DATE
					NUMBER	REVISION NO. AND DATE	
37	CONSOLIDATED-VULTEE AIRCRAFT CORP, STINSON DIVISION	V-77 (Army AT-19)	A-774	CAR PART 4a and Amendments Listed in TCDS No. A-774	AFC-K007	C 11/11/2010*	02/05/1996
38	CONSOLIDATED-VULTEE AIRCRAFT CORP, STINSON DIVISION	L-1, L-1A, L-1B, L-1C, L-1D, L-1E, L-1F	LTC-26	CAR PART 9 and Amendments Listed in TCDS No. LTC-26	AFC-K007	C 11/11/2010*	10/3/2012
39	CONSOLIDATED-VULTEE AIRCRAFT CORP, STINSON DIVISION	SM-8A	ATC 295	ATC 295 as specified	AFC-K007	C 11/11/2010*	10/3/2012
40	CONSOLIDATED-VULTEE AIRCRAFT CORP, STINSON DIVISION	SR-5, SR-5A (Army L-12), SR-5B, SR-5C, SR-5E	ATC 530	ATC 530 as specified	AFC-K007	C 11/11/2010*	10/3/2012
41	CONSOLIDATED-VULTEE AIRCRAFT CORP, STINSON DIVISION	SR-6, SR-6A, SR-6B, SR-6C	ATC 580	ATC 580 as specified	AFC-K007	C 11/11/2010*	10/3/2012
42	CONSOLIDATED-VULTEE AIRCRAFT CORP, STINSON DIVISION	SR-7A, SR-7B, SR-7C	ATC 594	ATC 594 as specified	AFC-K007	C 11/11/2010*	10/3/2012
43	CONSOLIDATED-VULTEE AIRCRAFT CORP, STINSON DIVISION	SR-8A, SR-8B, SR-8C	ATC 608	ATC 608 as specified	AFC-K007	C 11/11/2010*	10/3/2012
44	CONSOLIDATED-VULTEE AIRCRAFT CORP, STINSON DIVISION	SR-9A, SR-9B (Army UC-81N), SR-9C (Army UC-81C)	ATC 621	ATC 621 as specified	AFC-K007	C 11/11/2010*	10/3/2012



**FAA APPROVED MODEL LIST (AML) SA00024NY**  
**AIRWOLF FILTER CORP**  
**FOR INSTALLING**  
**REMOTE MOUNT OIL FILTER KIT**

ITEM	AIRCRAFT MAKE	AIRCRAFT MODEL	ORIGINAL TYPE CERTIFICATE NUMBER	CERTIFICATION BASIS FOR ALTERATION	INSTALLATION INSTRUCTIONS		AML AMENDMENT DATE
					NUMBER	REVISION NO. AND DATE	
45	CONSOLIDATED-VULTEE AIRCRAFT CORP, STINSON DIVISION	SR-10B, SR-10C (Army UC-81E), SR-10G (Army UC-81A), SR-10G3, SR-10H, SR-10J, SR-10J3	TC 678	TC 678 as specified	AFC-K007	C 11/11/2010*	10/3/2012
46	CONSOLIDATED-VULTEE AIRCRAFT CORP, STINSON DIVISION	Stinson JR SR, JR SR-2	ATC 510	ATC 510 as specified	AFC-K007	C 11/11/2010*	10/3/2012
47	CUB CRAFTERS INC	CC18-180, CC18-180A	A00006SE	14 CFR PART 23 and Amendments Listed in TCDS No. A00006SE	AFC-K007	C 11/11/2010*	10/3/2012
48	CURTISS-WRIGHT	Travel Air 4000 with Lycoming Engine STC	ATC 32	ATC 32 as specified	AFC-K007	C 11/11/2010*	10/3/2012
49	DAIMLER CHRYSLER AEROSPACE AG	BO-209-150 FV & RV BO-209-160 FV & RV BO-209-150 FF	A27EU	14 CFR PART 23 and Amendments Listed in TCDS No. A27EU	AFC-K007	C 11/11/2010*	10/3/2012
50	DE HAVILLAND SUPPORT LIMITED	Beagle B.121 Series 2, Series 3	A22EU	14 CFR PART 23 and Amendments Listed in TCDS No. A22EU	AFC-K007	C 11/11/2010*	10/3/2012
51	DIAMOND AIRCRAT INDUSTRIES GmbH	DA 40, DA 40 F	A47CE	14 CFR PART 23 and Amendments Listed in TCDS No. A47CE	AFC-K007	C 11/11/2010*	10/3/2012
52	DORNIER LUFTFAHRT GmbH	DO 28D, DO 28D-1	A16EU	14 CFR PART 23 and Amendments Listed in TCDS No. A16EU	AFC-K007	C 11/11/2010*	10/3/2012
53	EADS-PZL "WARSZAWA-OKECIE" S.A.	PZL-104M WILGA 2000 PZL-104MA WILGA 2000	A55EU	14 CFR PART 23 and Amendments Listed in TCDS No. A55EU	AFC-K007	C 11/11/2010*	10/3/2012
54	EADS-PZL "WARSZAWA-OKECIE" S.A.	PZL-KOLIBER 150A PZL-KOLIBER 160A	A69EU	14 CFR PART 23 and Amendments Listed in TCDS No. A69EU	AFC-K007	C 11/11/2010*	10/3/2012
55	FFT GESELLSCHAFT FUR FLUGZEUG	SC 01 B-160	A58EU	14 CFR PART 23 and Amendments Listed in TCDS No. A58EU	AFC-K007	C 11/11/2010*	10/3/2012

**FAA APPROVED MODEL LIST (AML) SA00024NY**

**AIRWOLF FILTER CORP  
FOR INSTALLING  
REMOTE MOUNT OIL FILTER KIT**

ITEM	AIRCRAFT MAKE	AIRCRAFT MODEL	ORIGINAL TYPE CERTIFICATE NUMBER	CERTIFICATION BASIS FOR ALTERATION	INSTALLATION INSTRUCTIONS		AML AMENDMENT DATE
					NUMBER	REVISION NO. AND DATE	
56	FLS AEROSPACE (Lovaux)	OA7 Optica Series 300	A64EU	14 CFR PART 23 and Amendments Listed in TCDS No. A64EU	AFC-K007	C 11/11/2010*	10/3/2012
57	EXTRA FLUGZEUGBAU GmbH	EA-300, EA-300/S, EA-300/L, EA-300/200, EA-300/LC	A67EU	14 CFR PART 23 and Amendments Listed in TCDS No. A67EU	AFC-K007	C 11/11/2010*	08/15/2016
58	FOUND AIRCRAFT CANADA INC.	FBA-2C, FBA-2C1, FBA-2C2, FBA-2C3	A7EA	CAR PART 3and 14 CFR PART 23 and Amendments Listed in TCDS No. A7EA	AFC-K007	C 11/11/2010*	10/3/2012
59	FLUFZEUGWERKE ALTENRHEIM AG	AS202/15, AS202/18A, AS202/18A4	A34EU	14 CFR PART 23 and Amendments Listed in TCDS No. A34EU	AFC-K007	C 11/11/2010*	10/3/2012
60	FS 2001 CORP (Piper)	J5B (Army L-4G), J5C, AE-1, HE-1	A-725	CAR PART 4a and Amendments Listed in TCDS No. A-725	AFC-K007	C 11/11/2010*	10/3/2012
61	FS 2002 CORP (Piper)	PA-14	A-797	CAR PART 3and Amendments Listed in TCDS No. A-797	AFC-K007	C 11/11/2010*	10/3/2012
62	FS 2003 CORP (Piper)	PA-12, PA-12S	A-780	CAR PART 3and Amendments Listed in TCDS No. A-780	AFC-K007	C 11/11/2010*	11/25/1995
63	GENERAL AVIA ConstruzioniAeronaut iche	F22B, F22C, F22R	A75EU	14 CFR PART 23 and Amendments Listed in TCDS No. A75EU	AFC-K007	C 11/11/2010*	10/3/2012
64	GIPPSLAND AERONAUTICS PTY LTD	GA200, GA200C	A00001LA	14 CFR PART 23 and Amendments Listed in TCDS No. A00001LA	AFC-K007	C 11/11/2010*	10/3/2012
65	GIPPSLAND AERONAUTICS PTY LTD	GA8, GA8-TC320	A00011LA	14 CFR PART 23 and Amendments Listed in TCDS No. A00011LA	AFC-K007	C 11/11/2010*	10/3/2012
66	GROB-WERKE	G115, G115A, G115B, G115C, G115C2, G115D, G115D2. G115EG	A57EU	14 CFR PART 23 and Amendments Listed in TCDS No. A57EU	AFC-K007	C 11/11/2010*	10/3/2012



**FAA APPROVED MODEL LIST (AML) SA00024NY**

**AIRWOLF FILTER CORP**

**FOR INSTALLING**

**REMOTE MOUNT OIL FILTER KIT**

ITEM	AIRCRAFT MAKE	AIRCRAFT MODEL	ORIGINAL TYPE CERTIFICATE NUMBER	CERTIFICATION BASIS FOR ALTERATION	INSTALLATION INSTRUCTIONS		AML AMENDMENT DATE
					NUMBER	REVISION NO. AND DATE	
67	HAWKER BEECHCRAFT CORPORATION (Beech)	A36 with Lycoming Engine STC	3A15	CAR PART 3and Amendments Listed in TCDS No. 3A15	AFC-K007	C 11/11/2010*	10/3/2012
68	HAWKER BEECHCRAFT CORPORATION (Beech)	19A, B19, M19A, 23, A23, A23A, A23-19, A23-24, B23, C23, A24, A24R, B24R, C24R	A1CE	CAR PART 3and Amendments Listed in TCDS No. A1CE	AFC-K007	C 11/11/2010*	11/22/1994
69	HAWKER BEECHCRAFT CORPORATION (Beech)	95, B95, B95A, D95A, E95, 56TC, A56TC	3A16	CAR PART 3and Amendments Listed in TCDS No. 3A16	AFC-K007	C 11/11/2010*	11/22/1994
70	HAWKER BEECHCRAFT CORPORATION (Beech)	50 (L-23A), B50 (L-23B, L-23D, RL-23D), C50, D50 (L-23E), D50A, D50B, D50C, D50E, D50E-5990, E50, F50, G50, H50, J50	5A4	CAR PART 3and Amendments Listed in TCDS No. 5A4	AFC-K007	C 11/11/2010*	05/15/1999
71	HAWKER BEECHCRAFT CORPORATION (Beech)	76	A29CE	14 CFR PART 23 and Amendments Listed in TCDS No. A29CE	AFC-K007	C 11/11/2010*	10/3/2012
72	HAWKER BEECHCRAFT CORPORATION (Beech)	77	A30CE	14 CFR PART 23 and Amendments Listed in TCDS No. A30CE	AFC-K007	C 11/11/2010*	10/3/2012
73	HAWKER BEECHCRAFT CORPORATION (Beech)	60, A60, B60	A12CE	14 CFR PART 23 and Amendments Listed in TCDS No. A12CE	AFC-K007	C 11/11/2010*	10/3/2012
74	HAWKER BEECHCRAFT CORPORATION (Beech)	65(L-23F), A65, A65-8200, 65-80, 65-A80, 65-A80-8800, 65-B80, 65-88, 70	3A20	CAR PART 3and Amendments Listed in TCDS No. 3A20	AFC-K007	C 11/11/2010*	05/23/1997

**FAA APPROVED MODEL LIST (AML) SA00024NY**  
**AIRWOLF FILTER CORP**  
**FOR INSTALLING**  
**REMOTE MOUNT OIL FILTER KIT**

ITEM	AIRCRAFT MAKE	AIRCRAFT MODEL	ORIGINAL TYPE CERTIFICATE NUMBER	CERTIFICATION BASIS FOR ALTERATION	INSTALLATION INSTRUCTIONS		AML AMENDMENT DATE
					NUMBER	REVISION NO. AND DATE	
75	HELIO AIRCRAFT LLC	H-295 (USAF U10D), HT-295, H-391 (USAF YL-24), H-391B, H-395 (USAF L-28A or U-10B), H-395A, H-250, H-700, H-800	1A8	CAR PART 3and Amendments Listed in TCDS No. 1A8	AFC-K007	C 11/11/2010*	05/15/1999
76	HELIO AIRCRAFT LLC	500	A2EA	CAR PART 3and Amendments Listed in TCDS No. A2EA	AFC-K007	C 11/11/2010*	10/3/2012
77	LAVIA ARGENTINA S.A. (Piper Laviasa)	PA-25, PA-25-235, PA-25-260	2A8	CAR PART 3and Amendments Listed in TCDS No. 2A8	AFC-K007	C 11/11/2010*	11/25/1995
78	LAVIA ARGENTINA S.A. (Piper, Laviasa)	PA-25, PA-25-235, PA-25-260	2A10	CAR PART 8.10(b) and Amendments Listed in TCDS No. 2A10	AFC-K007	C 11/11/2010*	11/25/1995
79	MAULE AEROSPACE TECHNOLOGY, INC	M-4-180V, M-5-180C, M-5-200, M-5-210TC, M-5-235C, M-6-180, M-6-235, M-7-235, M-7-235A, M-7-235B, M-7-235C, M-7-260, M-7-260C, MT-7-235, MT-7-260, MX-7-160, MX-7-160C, MX-7-180, MX-7-180A, MX-7-180AC, MX-7-180B, MX-7-180C, MX-7-235, MXT-7-160, MXT-7-180, MXT-7-180A, M-8-235, M-9-235	3A23	CAR PART 3and Amendments Listed in TCDS No. 3A23	AFC-K007	C 11/11/2010*	10/3/2012
80	M.H.SPINKS, SR. SPINKS INDUSTRIES (Rawdon)	T-1	A-794	CAR PART 4a and Amendments Listed in TCDS No. A-794	AFC-K007	C 11/11/2010*	10/3/2012



**FAA APPROVED MODEL LIST (AML) SA00024NY**

**AIRWOLF FILTER CORP  
FOR INSTALLING  
REMOTE MOUNT OIL FILTER KIT**

ITEM	AIRCRAFT MAKE	AIRCRAFT MODEL	ORIGINAL TYPE CERTIFICATE NUMBER	CERTIFICATION BASIS FOR ALTERATION	INSTALLATION INSTRUCTIONS		AML AMENDMENT DATE
					NUMBER	REVISION NO. AND DATE	
81	MICCO AIRCRAFT CO INC. (Meyers, LanShe)	MAC-145A, MAC-145B	3A1	14 CFR PART 23 and Amendments Listed in TCDS No. 3A1	AFC-K007	C 11/11/2010*	10/3/2012
82	MOONEY AIRCRAFT CORPORATION	M-22	A6SW	CAR PART 3and Amendments Listed in TCDS No. A6SW	AFC-K007	C 11/11/2010*	10/3/2012
83	MOONEY AVIATION COMPANY INC	M20, M20A, M20B, M20C, M20D, M20E, M20F, M20G, M20J, M20M	2A3	CAR PART 3and Amendments Listed in TCDS No. 2A3	AFC-K007	C 11/11/2010*	11/04/1993
84	MOONEY MTE AIRCRAFT CORP	M18-L, M18-LA,	A-803	CAR PART 3and Amendments Listed in TCDS No. A-803	AFC-K007	C 11/11/2010*	10/3/2012
85	MOROVAN NATIONAL CORP.	ZLIN 526L	A30EU	14 CFR PART 23 and Amendments Listed in TCDS No. A30EU	AFC-K007	C 11/11/2010*	10/3/2012
86	NATIONAL AERONCA ASSOCIATION	50-TL, 65-TC (Army L-3J), 65-TL, 65-TAL	A-728	CAR PART 4a and Amendments Listed in TCDS No. A-728	AFC-K007	C 11/11/2010*	10/3/2012
87	PIPER AIRCRAFT INC.	J3L, J3L-S, J3L-65 (Army L-4C), J3L-65S	A-698	CAR PART 4a and Amendments Listed in TCDS No. A-698	AFC-K007	C 11/11/2010*	10/3/2012
88	PIPER AIRCRAFT INC.	PA-15	A-800	CAR PART 3and Amendments Listed in TCDS No. A-800	AFC-K007	C 11/11/2010*	10/3/2012
89	PIPER AIRCRAFT INC.	PA-16, PA-16S	1A1	CAR PART 3and Amendments Listed in TCDS No. 1A1	AFC-K007	C 11/11/2010*	02/05/1996
90	PIPER AIRCRAFT INC.	PA-20, PA-20S, PA-20-115, PA-20S-115, PA-20-135, PA-20S-135	1A4	CAR PART 3and Amendments Listed in TCDS No. 1A4	AFC-K007	C 11/11/2010*	02/05/1996
91	PIPER AIRCRAFT INC.	PA-22, PA-22-108, PA-22-135, PA-22S-135, PA-22-150, PA-22S-150, PA-22-160, PA-22S-160	1A6	CAR PART 3and Amendments Listed in TCDS No. 1A6	AFC-K007	C 11/11/2010*	05/25/1994

**FAA APPROVED MODEL LIST (AML) SA00024NY**

**AIRWOLF FILTER CORP**

**FOR INSTALLING**

**REMOTE MOUNT OIL FILTER KIT**

ITEM	AIRCRAFT MAKE	AIRCRAFT MODEL	ORIGINAL TYPE CERTIFICATE NUMBER	CERTIFICATION BASIS FOR ALTERATION	INSTALLATION INSTRUCTIONS		AML AMENDMENT DATE
					NUMBER	REVISION NO. AND DATE	
92	PIPER AIRCRAFT INC.	PA-22-135, PA-22-150, PA-22-160, PA-22-108 Equipped with Lycoming O360-A4A Engines per STC SA181RM	1A6	CAR PART 3and Amendments Listed in TCDS No. 1A6	AFC-K007	C 11/11/2010*	10/3/2012
93	PIPER AIRCRAFT INC.	PA-23, PA-23-160, PA-23-235, PA-23-250, PA-23-250 (Navy UO-1), PA-23-E250	1A10	CAR PART 3and Amendments Listed in TCDS No. 1A10	AFC-K007	C 11/11/2010*	10/3/2012
94	PIPER AIRCRAFT INC.	PA-24, PA-24-250, PA-24-260, PA-24-400	1A15	CAR PART 3and Amendments Listed in TCDS No. 1A15	AFC-K007	C 11/11/2010*	11/22/1994
95	PIPER AIRCRAFT INC.	PA-28-140, PA-28-150, PA-28-151, PA-28-160, PA-28-161, PA-28-180, PA-28-181, PA-28S-160, PA-28S-180, PA-28R-180, PA-28R-200, PA-28R-201, PA-28RT-201, PA-28-235, PA-28-236	2A13	CAR PART 3and Amendments Listed in TCDS No. 2A13	AFC-K007	C 11/11/2010*	05/25/1994
96	PIPER AIRCRAFT INC.	PA-30, PA-39, PA-40	A1EA	CAR PART 3and Amendments Listed in TCDS No. A1EA	AFC-K007	C 11/11/2010*	11/25/1995
97	PIPER AIRCRAFT INC.	PA-31, PA-31-300, PA-31-325, PA-31-350	A20SO	CAR PART 3and Amendments Listed in TCDS No. A20SO	AFC-K007	C 11/11/2010*	05/23/1997
98	PIPER AIRCRAFT INC.	PA-32-260, PA-32-300, PA-32-301, PA-32-301T, PA-32R-300, PA-32R-301 (SP), PA-32R-301 (HP), PA-32R-301T, PA-32RT-300, PA-32RT-300T, PA-32S-300, PA-32-301FT, PA-32-301XTC	A3SO	CAR PART 3and Amendments Listed in TCDS No. A3SO	AFC-K007	C 11/11/2010*	10/3/2012



**FAA APPROVED MODEL LIST (AML) SA00024NY**

**AIRWOLF FILTER CORP  
FOR INSTALLING  
REMOTE MOUNT OIL FILTER KIT**

ITEM	AIRCRAFT MAKE	AIRCRAFT MODEL	ORIGINAL TYPE CERTIFICATE NUMBER	CERTIFICATION BASIS FOR ALTERATION	INSTALLATION INSTRUCTIONS		AML AMENDMENT DATE
					NUMBER	REVISION NO. AND DATE	
99	PIPER AIRCRAFT INC.	PA-34-200	A7SO	14 CFR PART 23 and Amendments Listed in TCDS No. A7SO	AFC-K007	C 11/11/2010*	10/3/2012
100	PIPER AIRCRAFT INC.	PA-36-300, PA-36-375	A9SO	14 CFR PART 23 and Amendments Listed in TCDS No. A9SO	AFC-K007	C 11/11/2010*	10/3/2012
101	PIPER AIRCRAFT INC.	PA-38-112	A18SO	14 CFR PART 23 and Amendments Listed in TCDS No. A18SO	AFC-K007	C 11/11/2010*	10/3/2012
102	PIPER AIRCRAFT INC.	PA-44-180, PA-44-180T	A19SO	14 CFR PART 23 and Amendments Listed in TCDS No. A19SO	AFC-K007	C 11/11/2010*	10/3/2012
103	PIPER AIRCRAFT INC.	PA-46-350P, PA-46-350T	A25SO	14 CFR PART 23 and Amendments Listed in TCDS No. A25SO	AFC-K007	C 11/11/2010*	10/3/2012
104	REVO, INC. (Colonial, Lake)	Colonial C-1, Colonial C-2, Lake LA-4, Lake LA-4A, Lake LA-4P, Lake LA-4-200, Lake Model 250	1A13	CAR PART 3and 14 CFR PART 23 and Amendments Listed in TCDS No. 1A13	AFC-K007	C 11/11/2010*	05/23/1997
105	RUSCHMEYER LUFTFAHRTTECHNIK	R90-230RG	A77EU	14 CFR PART 23 and Amendments Listed in TCDS No. A77EU	AFC-K007	C 11/11/2010*	10/3/2012
106	SEASTAR CORP (Bohica Inc, Teal, Schweizer, Thurston)	TSC-1A, TSC-1A1, TSC-1A2	A15EA	14 CFR PART 23 and Amendments Listed in TCDS No. A15EA	AFC-K007	C 11/11/2010*	10/3/2012
107	SIERRA HOTEL AERO, INC. (Navion, Ryan)	Navion B	A-782	CAR PART 3and Amendments Listed in TCDS No. A-782	AFC-K007	C 11/11/2010*	10/3/2012
108	SIMMERING GRAZ PAUKER A.G.	SGP 222, SGP 222-A	A2EU	CAR PART 3and Amendments Listed in TCDS No. A2EU	AFC-K007	C 11/11/2010*	10/3/2012
109	SKY ENTERPRISES, INC. (Republic)	RC-3	A-769	CAR PART 3and Amendments Listed in TCDS No. A-769	AFC-K007	C 11/11/2010*	10/3/2012

**FAA APPROVED MODEL LIST (AML) SA00024NY**

**AIRWOLF FILTER CORP  
FOR INSTALLING  
REMOTE MOUNT OIL FILTER KIT**

ITEM	AIRCRAFT MAKE	AIRCRAFT MODEL	ORIGINAL TYPE CERTIFICATE NUMBER	CERTIFICATION BASIS FOR ALTERATION	INSTALLATION INSTRUCTIONS		AML AMENDMENT DATE
					NUMBER	REVISION NO. AND DATE	
110	SKY INTERNATIONAL (Aviat, Pitts)	S-1S, S-1T, S-2, S-2A, S-2S, S-2B S-2C	A8SO	14 CFR PART 23 and Amendments Listed in TCDS No. A8SO	AFC-K007	C 11/11/2010*	07/22/1993
111	SLINGSBY AVIATION LTD.	T67M260, T67M260-T3A	A73EU	14 CFR PART 23 and Amendments Listed in TCDS No. A73EU	AFC-K007	C 11/11/2010*	10/3/2012
112	INC SME AERO.	MD3-160	A65EU	14 CFR PART 23 and Amendments Listed in TCDS No. A65EU	AFC-K007	C 11/11/2010*	10/3/2012
113	S.O.C.A.T.A. – GROUPE AEROSPATIALE	Rallye Series, MS892A-150, MS892E-150, MS893A, MS893E, 150T, 150ST, 235C, 235E	7A14	CAR PART 3and Amendments Listed in TCDS No. 7A14	AFC-K007	C 11/11/2010*	10/3/2012
114	S.O.C.A.T.A. – GROUPE AEROSPATIALE	TB9, TB10, TB20, TB21, TB200	A51EU	14 CFR PART 23 and Amendments Listed in TCDS No. A51EU	AFC-K007	C 11/11/2010*	10/3/2012
115	S.O.C.A.T.A. – GROUPE AEROSPATIALE (Gulfstream, Grumman, American General)	GA-7	A17SO	14 CFR PART 23 and Amendments Listed in TCDS No. A17SO	AFC-K007	C 11/11/2010*	10/3/2012
116	STOL AIRCRAFT CORPORATION	UC-1	A6EA	CAR PART 3and Amendments Listed in TCDS No. A6EA	AFC-K007	C 11/11/2010*	10/3/2012
117	SWIFT MUSEUM FOUNDATION, INC. (Globe)	GC-1A, GC-1B with Lycoming Engine STC	A-766	CAR PART 4a and Amendments Listed in TCDS No. A-766	AFC-K007	C 11/11/2010*	10/3/2012
118	TAYLORCRAFT 2000 LLC	F21, F21A, F21B, F22, F22A, F22B, F22C	1A9	CAR PART 3and Amendments Listed in TCDS No. 1A9	AFC-K007	C 11/11/2010*	02/05/1996
119	THE DON LUSCOMBE AVIATION HISTORY FOUNDATION INC	8B	A-694	CAR PART 4a and Amendments Listed in TCDS No. A-694	AFC-K007	C 11/11/2010*	10/3/2012



**FAA APPROVED MODEL LIST (AML) SA00024NY**

**AIRWOLF FILTER CORP**

**FOR INSTALLING**

**REMOTE MOUNT OIL FILTER KIT**

ITEM	AIRCRAFT MAKE	AIRCRAFT MODEL	ORIGINAL TYPE CERTIFICATE NUMBER	CERTIFICATION BASIS FOR ALTERATION	INSTALLATION INSTRUCTIONS		AML AMENDMENT DATE
					NUMBER	REVISION NO. AND DATE	
120	<b>THOMAS H. McCLISH</b> (Funk)	B75L	A-715	CAR PART 4a and Amendments Listed in TCDS No. A-715	AFC-K007	C 11/11/2010*	10/3/2012
121	<b>TRUE FLIGHT HOLDINGS LLC</b> (Gulfstream, Grumman American, American General)	AA-5, AA-5A, AA-5B, AG-5B	A16EA	14 CFR PART 23 and Amendments Listed in TCDS No. A16EA	AFC-K007	C 11/11/2010*	02/05/1996
122	<b>TRUE FLIGHT HOLDINGS LLC</b> (Gulfstream, Grumman American, American General)	AA-1, AA-1A, AA-1B, AA-1C	A11EA	14 CFR PART 23 and Amendments Listed in TCDS No. A11EA	AFC-K007	C 11/11/2010*	11/22/1994
123	<b>TWIN COMMANDER AIRCRAFT CORPORATION</b> (Commander, Rockwell)	500, 500-B, 500-U, 500-S, 520, 560, 560-A, 560-E	6A1	CAR PART 3and Amendments Listed in TCDS No. 6A1	AFC-K007	C 11/11/2010*	10/3/2012
124	<b>TWIN COMMANDER AIRCRAFT CORPORATION</b> (Commander, Rockwell)	680F, 680FL, 680FL(P), 560F, 680, 680-E, 720	2A4	CAR PART 3and Amendments Listed in TCDS No. 2A4	AFC-K007	C 11/11/2010*	11/25/1995
125	<b>TWIN COMMANDER AIRCRAFT CORPORATION</b> (Commander, Rockwell)	700	A12SW	14 CFR PART 23 and Amendments Listed in TCDS No. A12SW	AFC-K007	C 11/11/2010*	10/3/2012

**FAA APPROVED MODEL LIST (AML) SA00024NY**  
**AIRWOLF FILTER CORP**  
**FOR INSTALLING**  
**REMOTE MOUNT OIL FILTER KIT**

ITEM	AIRCRAFT MAKE	AIRCRAFT MODEL	ORIGINAL TYPE CERTIFICATE NUMBER	CERTIFICATION BASIS FOR ALTERATION	INSTALLATION INSTRUCTIONS		AML AMENDMENT DATE
					NUMBER	REVISION NO. AND DATE	
126	UNIVAIR AIRCRAFT CORPORATION (Stinson)	108, 108-1, 108-2, 108-3, 108-5 With Lycoming Engine STC	A-767	CAR PART 3and Amendments Listed in TCDS No. A-767	AFC-K007	C 11/11/2010*	10/3/2012
127	VULCANAIR S.p.A (Partenavia)	P68, P68B, P68C, P68C-TC, P68 Observer, P68 Observer 2, P68 TC Observer	A31EU	14 CFR PART 23 and Amendments Listed in TCDS No. A31EU	AFC-K007	C 11/11/2010*	10/3/2012
128	WILLIAM J. GORES (AERONCA)	50-L, 50-LA, 65-LA, 65-LB (L-3G)	A-702	CAR PART 4a and Amendments Listed in TCDS No. A-702	AFC-K007	C 11/11/2010*	10/3/2012
129	ZLIN AIRCRAFT a.s.	Z-242L, Z-143L	A76EU	14 CFR PART 23 and Amendments Listed in TCDS No. A76EU	AFC-K007	C 11/11/2010*	10/3/2012
130	ZLIN AIRCRAFT a.s.	Zlin 526L	A30EU	14 CFR PART 23 and Amendments Listed in TCDS No. A30EU	AFC-K007	C 11/11/2010*	10/3/2012

\* Or Later FAA Approved Revisions

FAA Approved:   
 Roy Boffo  
 Manager, Propulsion Branch  
 Chicago Aircraft Certification Office

Date Amended: 7/22/93, 11/04/93, 2/3/94, 5/25/94,  
 11/22/94, 11/25/95, 2/5/96, 5/23/97,  
 5/15/99, 10/3/2012, and 8/15/2016

## INSTRUCTIONS FOR CONTINUED AIRWORTHINESS

**AIRWOLF FILTER CORP.**

**REMOTE MOUNTED OIL FILTER**

**On  
Aircraft Models Described on  
the Applicable AML or Otherwise Approved**

**Make:** \_\_\_\_\_

**Model:** \_\_\_\_\_

**Serial Number:** \_\_\_\_\_

**Reg. Number:** \_\_\_\_\_

**STC SA00024NY  
STC SA00079NY  
STC SA00433NY  
STC SA01282NY  
STC SA01406NY**

**RECORD OF REVISIONS**

REV. NO.	EFFECTED PAGE(S)	DESCRIPTION	DATE	APPROVED BY
IR	All	Initial Release	07/05/2012	David Braun, P.E., DER
A	All	Remove reference to Chapter 71 in Chapter 1 Section 4 (page 2). Revise Record of Revisions Table and page headers to agree with accepted format.	10/25/2013	David Braun, P.E., DER

**CHAPTER 1 INTRODUCTION**

1. Type Design Change: This type design change consists of the installation of the Airwolf Filter Corp. Remote Mount Oil Filter Kit pursuant to STCs SA00024NY, SA00079NY, SA00433NY, SA01282NY and SA01406NY on various aircraft makes and models as approved on the AML associated with the applicable STC. Each STC is tailored for aircraft powered by the engine applications as follows:  
 STC SA00024NY – Lycoming Engines  
 STC SA00079NY – Continental Engines  
 STC SA00433NY – Franklin Engines  
 STC SA01282NY – Pratt & Whitney Engines  
 STC SA01406NY – Curtis-Wright, Jacobs, Kinner, Ranger and Warner Engines.  
  
 Many aircraft engines were built with oil screens, or filters mounted on the engine in locations difficult to access. Oil screens are not filters and only prevent the large pieces from going through the engine. Oil filters trap small contaminants (dirt) preventing them from circulating through the engine. Remote Mount Oil Filter Kits replace the screen or difficult to access filter with a replaceable oil filter in a location which minimizes potential oil spills when servicing the oil filter.
2. Scope: The scope of this Instruction for Continued Airworthiness (ICA) focuses exclusively on Maintenance, Inspection & Airworthiness Limitations of this FAA-approved type design change.
3. Purpose: The purposes of this ICA are to apprise Owner/Operators who have modified their airplane pursuant to this type design change: (1) When, where & how to inspect; and (2) When to replace this type design to assure continued operational safety.
4. Arrangement: This ICA is a single document comprised of five (5) Chapters:  
 Chapter 1, Introduction;  
 Chapter 4, Airworthiness Limitations;  
 Chapter 5, Inspection Requirements & Overhaul Schedule;  
 Chapter 8, Weight and Balance;  
 Chapter 12, Servicing.



5. Applicability: This ICA is applicable to the aircraft noted on each STCs AML. In addition, it is applicable to aircraft which install the remote mounted oil filter system and receive a field approval.
6. Precautions: There are no Precautionary Notes in Airwolf Filter Corp. AFC-K000-ICA.
7. Referenced Publications: Airwolf Filter Corp. Installation Instructions as follows:  
STC SA00024NY – AFC-K007  
STC SA00079NY – AFC-K008  
STC SA00433NY – AFC-K010  
STC SA01282NY – AFC-K015  
STC SA01406NY – AFC-K017  
The maintenance and operations manual for the engine and the aircraft.
8. Distribution: Airwolf Filter Corp, will distribute this ICA to purchasers of Remote Oil Filter kits, and should the need arise to modify this ICA, the AEG-accepted revision will be available to all Owner/Operators. For Owner/Operators having internet access, the latest AEG- accepted revision to this ICA will be available for downloading from the Airwolf Filter Corp. website: <http://www.airwolf.com/>

#### CHAPTER 4 AIRWORTHINESS LIMITATIONS

There are no Airworthiness Limitations associated with this type design change.

The Airworthiness Limitations section is FAA approved and specifies maintenance required under Secs. 43.16 and 91.403 of the Federal Aviation Regulations unless an alternative program has been FAA approved."

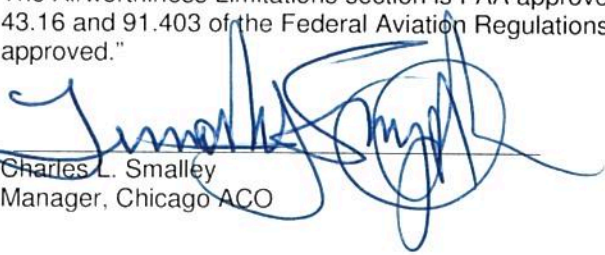
  
for Charles L. Smalley  
Manager, Chicago ACO

Date 10/29/2013

## CHAPTER 5 INSPECTION REQUIREMENTS & OVERHAUL SCHEDULE

### 1. INSPECTION REQUIREMENTS

Inspect for security at each annual or 100 hr. inspection. After any oil change, always ground run the engine and check for leaks..

At each oil change cut the old filter open with Airwolf AFC-470 oil filter cutter (or equivalent) and inspect for metal contamination or any evidence that may indicate impending engine problems.

### 2. OVERHAUL SCHEDULE

There are no changes to the overhaul schedule relating to Power Plant associated with this type design change.

## CHAPTER 8 WEIGHT and BALANCE

### 1. NET EFFECT:

Installation of the Remote Oil Filter Kit typically results in a five pound addition in weight. Because of the variety of the aircraft covered on each STC's AML, prior to installing the filter kit on the aircraft, weigh the filter kit, add the weight of the hoses, and subtract the oil screen or oil filter adapter removed from the engine and determine the net weight being added to the aircraft. Measure the locations relative to the datum for the moment arms if needed.

Airwolf Filter Corp. recommends that aircraft are weighed and a new weight and balance calculated after all modifications are made.

## CHAPTER 12 SERVICING

### 1. OIL SYSTEM

Oil system to be serviced in accordance with the most recent available engine operation manual or maintenance manual for the engine installed on the aircraft, and the applicable aircraft maintenance manual. Oil should be changed at least once every 12 months. Prior to each oil change run up the engine to operating temperature to assure complete draining of the oil. At each oil change, cut the old filter open with Airwolf AFC-470 oil filter cutter (or equivalent) and inspect for metal contamination or any evidence that may indicate impending engine problems.

To install the new oil filter, position the filter on the remote mounting adapter and tighten the filter to a torque of 18 to 20 ft. lbs. If a torque wrench is not available, tighten the filter with a suitable wrench, three quarters to one full turn after the filter gasket makes contact with the adapter face. Safety wire the filter to the remote mount adapter.

### 2. STANDARD HARDWARE

Hardware associated with this type design change are standard AN and MS hardware. Contact Airwolf Filter Corp. for spares and refer to the installation instructions when ordering.